



北京平和官方网站
Beijing Pinghe official website



北京平和官方微信
Beijing Pinghe official wechat



6年
质保
功能安全产品
Warranty
6 years!
Functional safety product

北京平和创业科技发展有限公司
Beijing Pinghe Chuangye Technology Development Co., Ltd

办公地址: 北京市大兴区天华大街5号13号楼6层
生产基地: 北京市中关村科技园区永兴路25号
河北省京津冀中南高科平和智能产业园

电话: 010-61252352-8005/8004, 61256219-8005/8004
服务: 400-711-6763
网址: www.bjpinghe.com
邮箱: linsen@bjpinghe.com

Office address: 6th Floor, Building 13, No. 5 Tianhua Street, Daxing District, Beijing, China
Production base: 25 Yongxing Road, Zhongguancun Science Park, Beijing
Beijing-Tianjin-Hebei Region Zhongnan High-tech Pinghe Intelligent Industrial Park
Tel: 010-61252352-8005/8004, 61256219-8005/8004
Service: 400-711-6763
Http: // www.bjpinghe.com
E-mail: linsen@bjpinghe.com

T系列选型样册

T series product catalogue

隔离式安全栅

Isolated Safety Barrier





Qualification and Honor 资质和荣誉

资质见实力，荣誉见证辉煌！截止 2021 年，北京平和共获得国内外认证机构颁发的 150 多个认证证书

Qualification witnesses strength, honor witnesses brilliance! As of 2021, Beijing Pinghe has been awarded more than 150 certifications..

ABOUT BEIJING PINGHE 关于北京平和

北京平和始创于 2004 年 1 月，座落于北京市中关村科技园，总注册资本 8000 万元，是一家致力于工业信号类接口模块仪表的国家级高新技术企业。作为行业公认的一线品牌，北京平和一直专注于工控产品的研发、生产和营销，拥有两大智能制造基地。产品广泛应用于军工核电、航天航空、石油化工、冶金电力、能源环保、船舶制造和生物医药等行业。至今国内外市场稳定运行 500 余万只，卓越的品质和优质的服务获得了广大合作伙伴的高度信赖和认可。

Beijing Pinghe was founded in January 2004 and is located in Beijing Zhongguancun Science and Technology Park with registered capital 80 million CNY. We are a national high-tech enterprise dedicated to industrial signal interface modules.

As a top brand recognized by the industry, Beijing Pinghe has main focused on R&D, production and sales in the industrial control area, possesses two big intelligent production bases. The products are broad-range used in the military nuclear power, aerospace, petrochemical, metallurgical power, energy and environmental protection, shipbuilding and biomedicine industries. So far, more than 5 million pieces run stable in domestic and foreign markets, our excellent quality and outstanding service have been highly recognized and praised by a vast number of partners.

- 国家级高新技术企业
National high-tech enterprise
- 北京市“专精特新”中小企业
Specialization, refinement, differentiation, innovation of small and medium-sized enterprise Beijing
- 北京市“专精特新”小巨人
Specialization, refinement, differentiation, innovation of Little Giant enterprise Beijing
- 全国监督检查产品质量稳定合格企业
National supervision and inspection product qualified enterprise of stable quality
- 北京市两化融合试点企业
Pilot Enterprise Beijing of Integration of Informatization and Industrialization
- 中国制药装备行业协会会员单位
Member of China Association For Pharmaceutical Equipment
- 中国仪器仪表学会会员单位
Member of China Instrument and Control Society
- 中国计量协会会员单位
Member of China Metrology Association
- TÜV 功能安全认证
TÜV Functional safety certification
- ATEX 防爆认证
Quality assurance certified according to ATEX Approval
- IECEx 防爆质量管理体系认证
Quality assurance certified according to IECEx Approval
- ISO 9001、ISO 14001、ISO 45001 管理体系认证
Quality assurance certified according to ISO 9001, ISO 14001, ISO 45001
- 防爆产品 CCC 强制性认证
China Compulsory Certification for explosion-proof products
- 北京市新技术新产品（服务）证书
Beijing New Technology and New Product (Service) Certificate
- 2020 年度仪表自动化创新产品（技术）奖
2020 Instrument Automation Innovation Product (Technology) Award



Excellent R&D Team 优秀的研发团队



北京平和得益于首都北京人才与技术优势，高级工程师占研发团队的 60%，研发人员占员工总数的 30% 以上。经过近 20 年积累，拥有多项专利和自主知识产权，掌握产品核心技术，充分满足了流程工业和过程工业等领域的需求。

We benefit from talent and technical advantages of the capital Beijing, our senior engineers account for 60% of the R&D team, and R&D personnel more than 30% of the total number of employees. In these nearly 20 years, we have obtained a number of patents and independent intellectual property rights, and mastered the core technologies of the products, which fully meets the requirements of process industry.

Partial test equipment 部分测试设备

EMC电磁兼容中试中心
EMC electromagnetic compatibility test lab

振动试验台
Vibration test benches

智能环境实验中心
An intelligent environmental experiment center

高低温试验箱
High and low temperature test chambers

防雷测试中心
A lightning protection test lab



Strict Quality Control System 严谨的品质管控体系

北京平和质量管控实施“全面质量管理”（Total Quality Management），在产品的设计、生产和服务的各个过程中实施严格的质量管控，为客户提供合格稳定的产品和及时优质的服务。北京平和始终以客户需求作为唯一服务标准，倾听客户声音，关注客户不断变化的需求，强化各个过程的质量管理，不断改进以提升客户满意度，矢志追求为客户提供高品质产品和全方位优质服务。

The quality control of Beijing Pinghe implements the "Total Quality Management" system standards, which carry out strict quality control in each process of product design, production and service, and provide customers with qualified and stable products as well as timely and high-quality services. Beijing Pinghe always takes the needs of customer as only service standard, listens to the opinion of customers, pays attention to the changing needs of customers, strengthens the quality management of each process, strives for providing customers with high-quality products and comprehensive services.



常用选型目录 Contents

◎ 检测端安全栅 Isolated Safety Barrier at Detection Side

类型 Type	型号 Model	输入信号 Input signal	输出信号 Output signal	通道数 Number of channels	页码 Page
模拟量 输入 Analog input	PHD-11TD-21	二、三线制变送器或电流源(HART)输入 Two or three-wire transmitter or current source(HART) input	4~20mA(HART)输出 4~20mA(HART) output	一入一出 1 input 1 output	8
	PHD-12TD-211	二、三线制变送器或电流源(HART)输入 Two or three-wire transmitter or current source(HART) input	4~20mA(HART)输出 4~20mA(HART) output	一入二出 1 input 2 outputs	10
	PHD-22TD-2121	二、三线制变送器或电流源(HART)输入 Two or three-wire transmitter or current source(HART) input	4~20mA(HART)输出 4~20mA(HART) output	二入二出 2 inputs 2 outputs	12
开关量 输入 Digital input	PHD-11TF-27	触点及NAMUR接近开关输入 Contact and NAMUR proximity switch input	继电器输出+报警 Relay output+alarm	一入一出 1 input 1 output	14
	PHD-12TF-277	触点及NAMUR接近开关输入 Contact and NAMUR proximity switch input	继电器输出 Relay output	一入二出 1 input 2 outputs	16
	PHD-22TF-2727	触点及NAMUR接近开关输入 Contact and NAMUR proximity switch input	继电器输出 Relay output	二入二出 2 inputs 2 outputs	18
	PHD-11TF-28	触点及NAMUR接近开关输入 Contact and NAMUR proximity switch input	晶体管输出+报警 Relay output+alarm	一入一出 1 input 1 output	20
	PHD-12TF-288	触点及NAMUR接近开关输入 Contact and NAMUR proximity switch input	晶体管输出 Relay output	一入二出 1 input 2 outputs	22
	PHD-22TF-2828	触点及NAMUR接近开关输入 Contact and NAMUR proximity switch input	晶体管输出 Relay output	二入二出 2 inputs 2 outputs	24
热电阻 热电偶 输入 RTD and TC input	PHD-11TZ-*1	热电阻输入 RTD input	4~20mA输出 4~20mA output	一入一出 1 input 1 output	26
	PHD-12TZ-*11	热电阻输入 RTD input	4~20mA输出 4~20mA output	一入二出 1 input 2 outputs	28
	PHD-22TZ-*1*1	热电阻输入 RTD input	4~20mA输出 4~20mA output	二入二出 2 inputs 2 outputs	30
	PHD-11TT-*1	热电偶输入 TC input	4~20mA输出 4~20mA output	一入一出 1 input 1 output	32
	PHD-12TT-*11	热电偶输入 TC input	4~20mA输出 4~20mA output	一入二出 1 input 2 outputs	34
	PHD-22TT-*1*1	热电偶输入 TC input	4~20mA输出 4~20mA output	二入二出 2 inputs 2 outputs	36
	PHD-11TT-88	热电偶输入 TC input	热电偶1:1输出 TC 1:1 output	一入一出 1 input 1 output	38

类型 Type	型号 Model	输入信号 Input signal	输出信号 Output signal	通道数 Number of channels	页码 Page
通讯信号 输入 Communication signal input	PHD-11TC-11	RS232输入 RS232 input	RS232输出 RS232 output	一入一出 1 input 1 output	40
	PHD-11TC-22	RS485全双工输入 RS485 full-duplex input	RS485全双工输出 RS485 full-duplex output	一入一出 1 input 1 output	42
	PHD-11TC-33*	RS485半双工输入 RS485 half-duplex input	RS485半双工输出 RS485 half-duplex output	一入一出 1 input 1 output	44
频率信号 输入 Frequency signal input	PHD-11TP-13	频率量≤100KHz, 配电12V输入 Frequency≤100KHz, Provided power 12V input	频率量1:1输出 Frequency 1:1 output	一入一出 1 input 1 output	46
	PHD-11TP-23	频率量≤100KHz, 配电24V输入 Frequency≤100KHz, Provided power 24V input	频率量1:1输出 Frequency 1:1 output	一入一出 1 input 1 output	48
◎ 操作端安全栅 Isolated Safety Barrier at Operating Side					
模拟量 输出 Analog Output	PHC-11TD-11	4~20mA(HART)输入 4~20mA(HART) input	4~20mA(HART)输出 4~20mA(HART) output	一入一出 1 input 1 output	50
	PHC-22TD-1111	4~20mA(HART)输入 4~20mA(HART) input	4~20mA(HART)输出 4~20mA(HART) output	二入二出 2 inputs 2 outputs	52
开关量输出 Digital Output	PHC-11TF-14	触点及逻辑电平输入 Contact and logic level input	开关量驱动输出 Switch driving output	一入一出 1 input 1 output	54

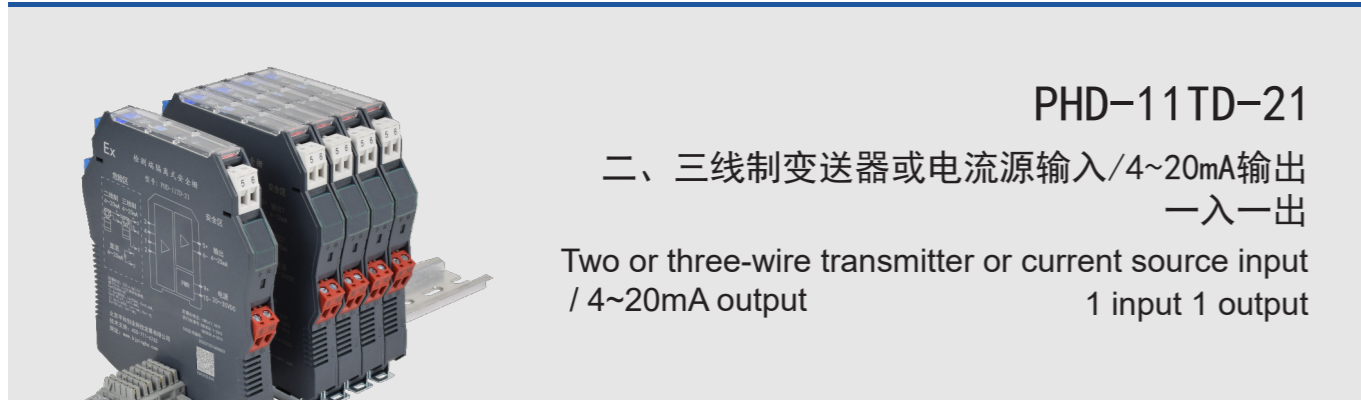

PHD-11TD-21

二、三线制变送器或电流源输入/4~20mA输出
一入一出

Two or three-wire transmitter or current source input / 4~20mA output
1 input 1 output

概述 Overview

隔离式检测端安全栅：PHD-11TD-21，模拟量输入输出，一路输入一路输出。

安全栅可实现将危险区变送器产生的4~20mA信号或直流4~20mA信号，隔离传送到安全区。输出4~20mA信号，现场变送器为二、三线制时，安全栅为变送器提供配电电源。

本产品需外接20~35VDC电源。
本产品支持HART信号，支持断线报警。

*注：本产品如果需要其它参数请联系技术人员。若输出为其他参数，以数字9表示，并在型号后，注明具体参数。
例：输入二线制、三线制或4~20mA，输出2~10V。型号：PHD-11TD-29 (2~10V)

*总线端子供电，详见附录。

Isolated safety barrier at detection side: PHD-11TD-21, analog input and output, single input and single output.

The isolated barrier can isolate and transmit the 4~20mA signal or DC 4~20 mA signal generated by the transmitter in the dangerous area to the safe area. the output signal is 4~20mA. When the transmitter is two-wire or three-wire system, the safety barrier provides power for the transmitter.

This product needs an external 20~35VDC power supply. This product supports HART signal and disconnection alarm.

* Note: If you need other parameters of this product, please contact our technical support. If the output is other parameters, it is indicated by the number 9, and the specific parameters are indicated after the model number.

Example: input 2-wire, 3-wire or 4~20mA, output 2~10V.

Model: PHD-11TD-29 (2~10V)

* Bus power supply, please see appendix for details.

接线图 Wiring diagram

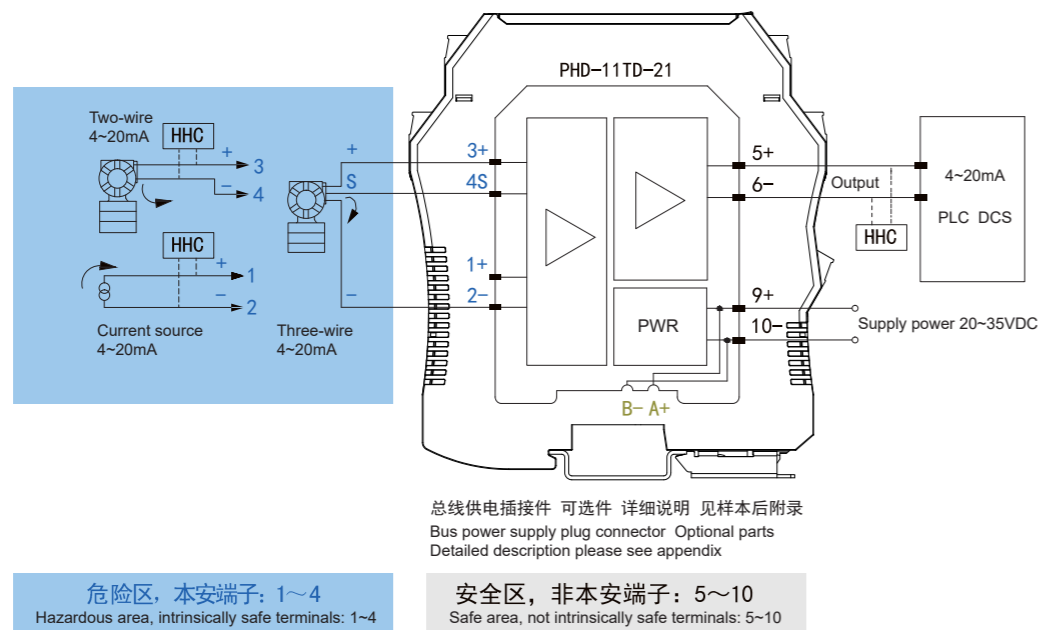

技术数据 Specifications

供电电压 Supply voltage	20~35VDC, 功耗<1.5W (24VDC, 变送器输入, 输出20mA时) 20~35VDC, power consumption<1.5W (when supply power 24VDC, transmitter input, output 20mA)
配电输出电源 Output power supply with provided power	电路输出20mA时, 配电电压≥16V When the circuit output is 20mA, the provided voltage is≥16V
输入信号 Input signal	二、三线制变送器或电流源信号 (HART) Two-wire or three-wire transmitter or current source signal (HART)
输出信号 Output signal	4~20mA (HART)
允许输出负载能力 Allowable output load capacity	0~500Ω (可定制) 0~500Ω (customizable)
输出精度 Output accuracy	0.1%F.S (典型值: 0.05%F.S) 0.1%FS (Typical value: 0.05% FS)
温度漂移 Temperature drift	0.005%F.S/°C
输入输出路数 Number of input and output	一路输入, 一路输出 1 input 1 output
适用的现场设备 Applicable field equipments	二、三线制变送器、电流源信号, 本产品适用于 (ABB、Fisher、Rosemount、Honeywell, 以及以引进技术的3351、EJA、SIEMENS等产品) 2-wire, 3-wire transmitter and current source signal, this product is suitable for ABB, Fisher, Rosemount, Honeywell, as well as 3351, EJA, SIEMENS and other products with imported technology.
温度参数 Temperature parameters	工作温度: -20°C~+60°C, 存储温度: -40°C~+80°C Working temperature: -20°C~+60°C, storage temperature: -40°C~+80°C
空气相对湿度 Relative humidity	10%~95%RH无凝露 10%~95% RH no condensation
绝缘强度 Insulation strength	本安端与非本安端 (≥3000VAC/min); 电源与非本安端之间 (≥1500VAC/min) Between intrinsically safe side and non-intrinsically safe side (≥3000VAC/min); between power supply and non-intrinsically safe side (≥1500VAC/min)
绝缘电阻 Insulation resistance	≥100MΩ (输入/输出/电源间) ≥100MΩ (between input/output/power supply)
电磁兼容性 Electromagnetic compatibility	符合IEC 61326-1 (GB/T 18268), IEC 61326-3-1 According to IEC 61326-1 (GB/T 18268), IEC 61326-3-1
防爆标志 Explosion-proof mark	[Exia Ga] IIC
功能安全认证 Functional safety certification	SIL2 符合IEC 61508 EN 61511标准 SIL2 according to IEC 61508 and EN 61511 standards
认证机构 Certification body	国家防爆电气产品质量监督检验中心CQST认证 CQST (China National Quality Supervision and Test Centre for Explosion Protected Electrical Products)
认证参数 (端子1-2之间) Certified parameters (between terminals 1-2)	Um=250V Uo=3.5V Io=-mA Co=100 μF Lo=-mH Po=-W
认证参数 (端子3-4之间) Certified parameters (between terminals 3-4)	Um=250V Uo=28V Io=93mA Co=0.05 μF Lo=2.4mH Po=0.65W
安装场所要求 Installation place requirements	可与具有IIA、IIB、IIC危险气体的0区本安仪表相连接 It can be connected with instruments in 0 zone with IIA, IIB, IIC dangerous gas
平均无故障时间 MTBF	≤100000小时 (h)

端子定义及外形尺寸 Terminal assignments and dimensions

端子 Terminal	接线端子功能定义 Terminal assignments	
9	供电电源+ Power supply +	20~35VDC
10	供电电源- Power supply -	
1	二线制 2-wire 输入+ Input+	电流源 Current source
2	二线制 2-wire 输入- Input-	
3	输入+ Input+ 配电电源+ Provided power supply+	4~20mA
4	输入- Input- 输入+ Input+	
5	输出+ Output+	4~20mA
6	输出- Output-	

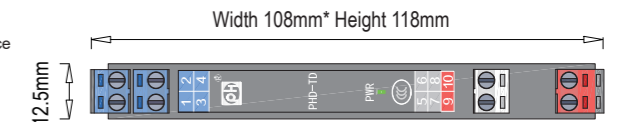

厚12.5mm × 宽108mm × 高118mm
Thickness 12.5mm* width 108mm* height 118mm

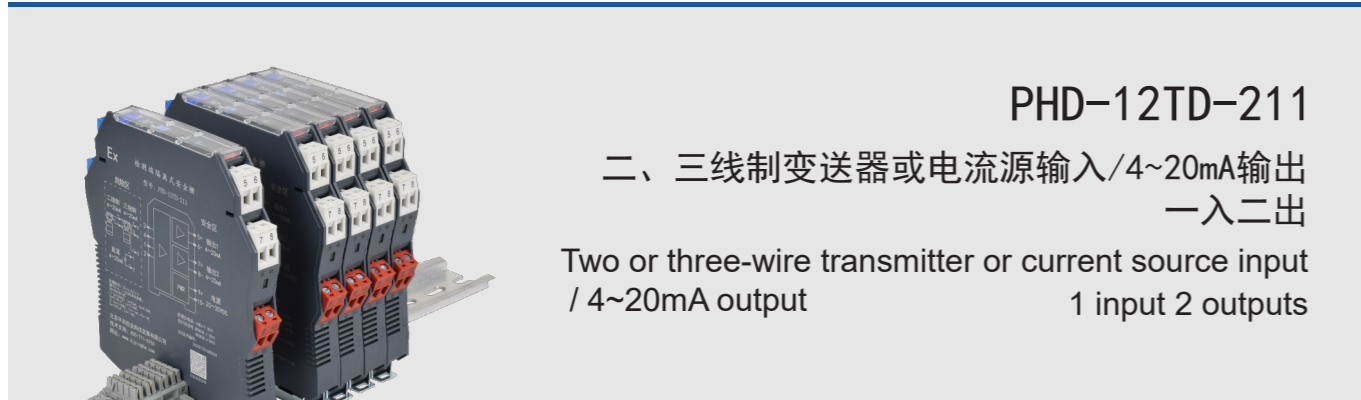

PHD-12TD-211

二、三线制变送器或电流源输入/4~20mA输出
一入二出

Two or three-wire transmitter or current source input / 4~20mA output
1 input 2 outputs

概述 Overview

隔离式检测端安全栅：PHD-12TD-211，模拟量输入输出，一路输入两路输出。

安全栅可实现将危险区变送器产生的4~20mA信号或直流4~20mA信号，隔离传送到安全区。输出4~20mA信号，现场变送器为二、三线制时，安全栅为变送器提供配电电源。

本产品需外接20~35VDC电源。
本产品支持HART信号。

*总线端子供电，详见附录。

Isolated safety barrier at detection side: PHD-12TD-211, single input and dual output with analog signal.

The isolated barrier can isolate and transmit the 4~20mA signal or DC 4~20 mA signal generated by the transmitter in the dangerous area to the safe area, the output signal is 4~20mA. When the transmitter is two-wire or three-wire system, the safety barrier provides power for the transmitter.

This product needs an external 20~35VDC power supply.
This product supports HART signal and disconnection alarm.

* Bus power supply, please see appendix for details.

接线图 Wiring diagram

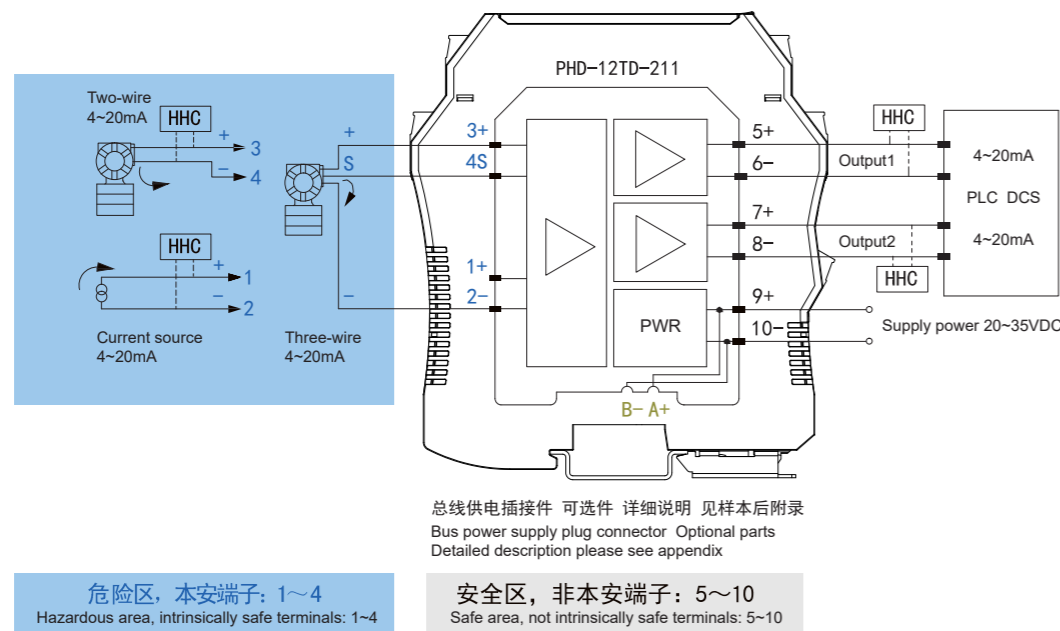

技术数据 Specifications

供电电压 Supply voltage	20~35VDC, 功耗<2W (24VDC, 变送器输入, 输出20mA时) 20~35VDC, power consumption<2W (when supply power 24VDC, transmitter input, output 20mA)
配电输出电源 Output power supply with provided power	电路输出20mA时, 配电电压≥16V When the circuit output is 20mA, the provided voltage is ≥16V
输入信号 Input signal	二、三线制变送器或电流源信号 (HART) Two-wire or three-wire transmitter or current source signal (HART)
输出信号 Output signal	4~20mA (HART)
允许输出负载能力 Allowable output load capacity	0~500Ω (可定制) 0~500Ω (customizable)
输出精度 Output accuracy	0.1%F.S (典型值: 0.05%F.S) 0.1%F.S (Typical value: 0.05% F.S)
温度漂移 Temperature drift	0.005%F.S/°C
输入输出路数 Number of input and output	一路输入, 两路输出 1 input 2 outputs
适用的现场设备 Applicable field equipments	二、三线制变送器、电流源信号, 本产品适用于 (ABB、Fisher、Rosemount、Honeywell, 以及以引进技术的3351、EJA、SIEMENS等产品) 2-wire, 3-wire transmitter and current source signal, this product is suitable for ABB, Fisher, Rosemount, Honeywell, as well as 3351, EJA, SIEMENS and other products with imported technology.
温度参数 Temperature parameters	工作温度: -20°C~+60°C, 存储温度: -40°C~+80°C Working temperature: -20°C~+60°C, storage temperature: -40°C~+80°C
空气相对湿度 Relative humidity	10%~95%RH无凝露 10%~95% RH no condensation
绝缘强度 Insulation strength	本安端与非本安端 (≥3000VAC/min); 电源与非本安端之间 (≥1500VAC/min) Between intrinsically safe side and non-intrinsically safe side (≥3000VAC/min); between power supply and non-intrinsically safe side (≥1500VAC/min)
绝缘电阻 Insulation resistance	≥100MΩ (输入/输出/电源间) ≥100MΩ (between input/output/power supply)
电磁兼容性 Electromagnetic compatibility	符合IEC 61326-1 (GB/T 18268), IEC 61326-3-1 According to IEC 61326-1 (GB/T 18268), IEC 61326-3-1
防爆标志 Explosion-proof mark	[Exia Ga] IIC
功能安全认证 Functional safety certification	SIL2 符合IEC 61508 EN 61511标准 SIL2 according to IEC 61508 and EN 61511 standards
认证机构 Certification body	国家防爆电气产品质量监督检验中心CQST认证 CQST (China National Quality Supervision and Test Centre for Explosion Protected Electrical Products)
认证参数 (端子1-2之间) Certified parameters (between terminals 1-2)	Um=250V Uo=3.5V Io=--mA Co=100 μF Lo=--mH Po=--W
认证参数 (端子3-4之间) Certified parameters (between terminals 3-4)	Um=250V Uo=28V Io=93mA Co=0.05 μF Lo=2.4mH Po=0.65W
安装场所要求 Installation place requirements	可与具有IIA、IIB、IIC危险气体的0区本安仪表相连接 It can be connected with instruments in 0 zone with IIA, IIB, IIC dangerous gas
平均无故障时间 MTBF	≤100000小时 (h)

端子定义及外形尺寸 Terminal assignments and dimensions

端子 Terminal	接线端子功能定义 Terminal assignments	
9	供电电源+ Power supply +	20~35VDC
10	供电电源- Power supply -	
	二线制 2-wire	电流源 Current source
	三线制 3-wire	
1	输入+ Input+	输入+ Input+
2	输入- Input-	输入- Input-
3	输入+ Input+	配电电源+ Provided power supply+
4	输入- Input-	输入+ Input+
5	输出1+ Output 1+	4~20mA
6	输出1- Output 1-	
7	输出2+ Output 2+	4~20mA
8	输出2- Output 2-	

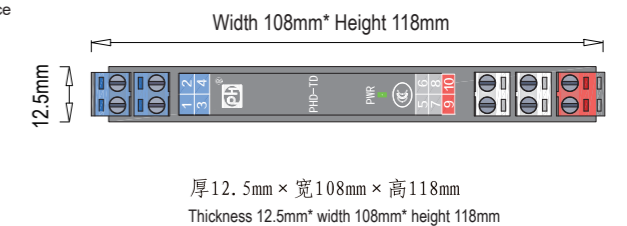

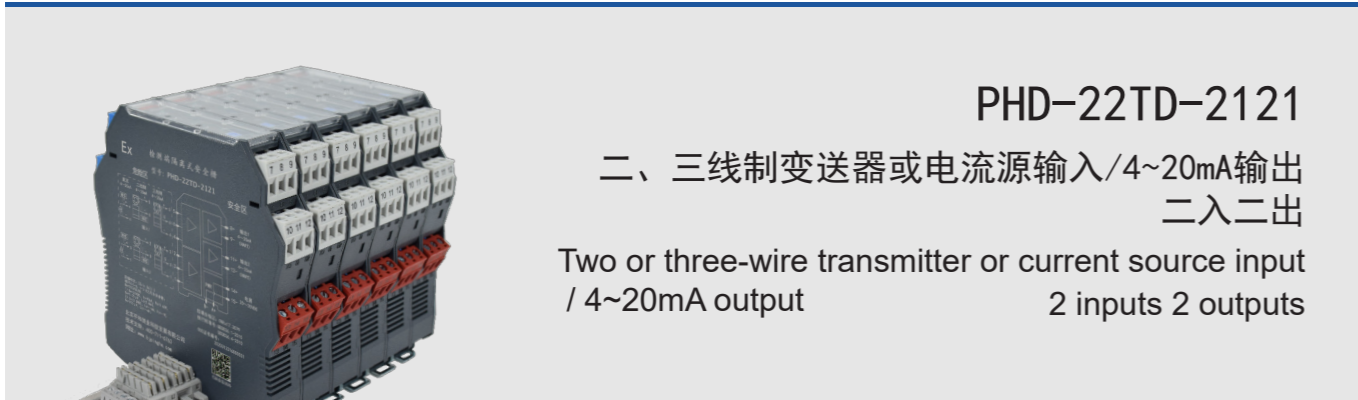

PHD-22TD-2121

二、三线制变送器或电流源输入/4~20mA输出
二入二出

Two or three-wire transmitter or current source input / 4~20mA output
2 inputs 2 outputs

概述 Overview

隔离式检测端安全栅：PHD-22TD-2121，模拟量输入输出，两路输入两路输出。

安全栅可实现将危险区变送器产生的4~20mA信号或直流4~20mA信号，隔离传送到安全区。输出4~20mA信号，现场变送器为二、三线制时，安全栅为变送器提供配电电源。

本产品需外接20~35VDC电源。
*总线端子供电，详见附录。

Isolated safety barrier at detection side: PHD-22TD-2121, dual input and dual output with analog signal.

The isolated barrier can isolate and transmit the 4~20mA signal or DC 4~20mA signal generated by the transmitter in the dangerous area to the safe area, the output signal is 4~20mA. When the transmitter is two-wire or three-wire system, the safety barrier provides power for the transmitter.

This product needs an external 20~35VDC power supply.
* Bus power supply, please see appendix for details.

接线图 Wiring diagram

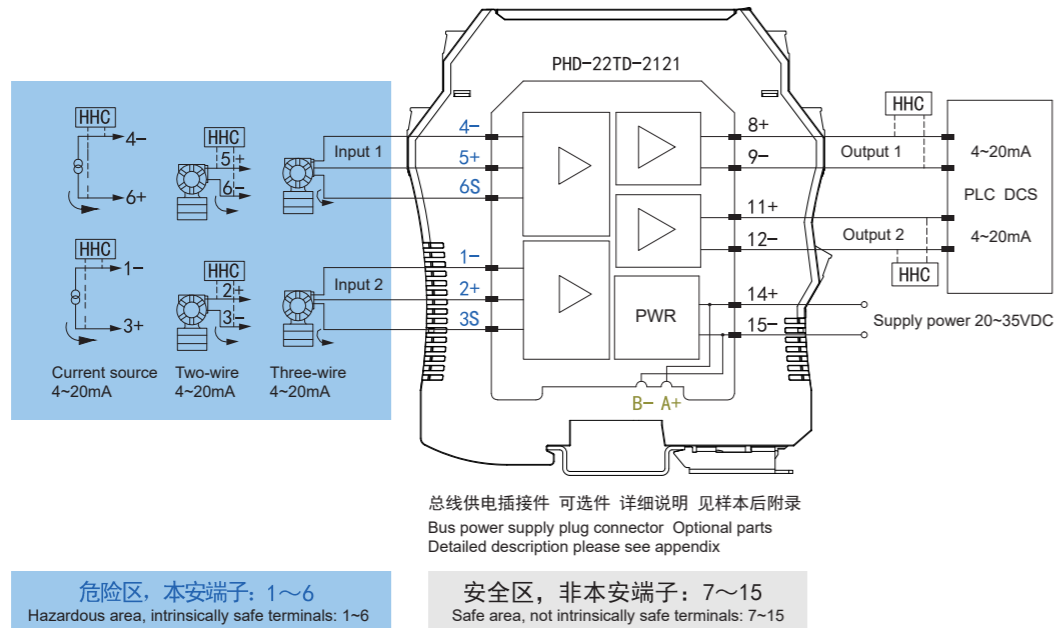

技术数据 Specifications

供电电压 Supply voltage	20~35VDC, 功耗<2.8W (24VDC, 变送器输入, 输出20mA时) 20~35VDC, power consumption<2.8W (when supply power 24VDC, transmitter input, output 20mA)
配电输出电源 Output power supply with provided power	电路输出20mA时, 配电电压≥16V When the circuit output is 20mA, the provided voltage is ≥16V
输入信号 Input signal	二、三线制变送器或电流源信号 (HART) Two-wire or three-wire transmitter or current source signal (HART)
输出信号 Output signal	4~20mA (HART)
允许输出负载能力 Allowable output load capacity	0~500Ω (可定制) 0~500Ω (customizable)
输出精度 Output accuracy	0.1%F.S (典型值: 0.05%F.S) 0.1%F.S (Typical value: 0.05% F.S)
温度漂移 Temperature drift	0.005%F.S/°C
输入输出路数 Number of input and output	两路输入, 两路输出 2 inputs 2 outputs
适用的现场设备 Applicable field equipments	二、三线制变送器、电流源信号, 本产品适用于 (ABB、Fisher、Rosemount、Honeywell, 以及引进技术的3351、EJA、SIEMENS等产品) 2-wire, 3-wire transmitter and current source signal, this product is suitable for ABB, Fisher, Rosemount, Honeywell, as well as 3351, EJA, SIEMENS and other products with imported technology.
温度参数 Temperature parameters	工作温度: -20°C~+60°C, 存储温度: -40°C~+80°C Working temperature: -20°C~+60°C, storage temperature: -40°C~+80°C
空气相对湿度 Relative humidity	10%~95%RH无凝露 10%~95% RH no condensation
绝缘强度 Insulation strength	本安端与非本安端 (≥3000VAC/min); 电源与非本安端之间 (≥1500VAC/min) Between intrinsically safe side and non-intrinsically safe side (≥3000VAC/min); between power supply and non-intrinsically safe side (≥1500VAC/min)
绝缘电阻 Insulation resistance	≥100MΩ (输入/输出/电源间) ≥100MΩ (between input/output/power supply)
电磁兼容性 Electromagnetic compatibility	符合IEC 61326-1 (GB/T 18268), IEC 61326-3-1 According to IEC 61326-1 (GB/T 18268), IEC 61326-3-1
防爆标志 Explosion-proof mark	[Exia Ga] IIC
功能安全认证 Functional safety certification	SIL2 符合IEC 61508 EN 61511标准 SIL2 according to IEC 61508 and EN 61511 standards
认证机构 Certification body	国家防爆电气产品质量监督检验中心CQST认证 CQST (China National Quality Supervision and Test Centre for Explosion Protected Electrical Products)
认证参数 (端子1-3、4-6之间) Certified parameters (between terminals 1-3,4-6)	Um=250V Uo=3.5V Io=--mA Co=100 μF Lo=--mH Po=--W
认证参数 (端子2-3、5-6之间) Certified parameters (between terminals 2-3,5-6)	Um=250V Uo=28V Io=93mA Co=0.05 μF Lo=2.4mH Po=0.65W
安装场所要求 Installation place requirements	可与具有IIA、IIB、IIC危险气体的0区本安仪表相连接 It can be connected with instruments in 0 zone with IIA, IIB, IIC dangerous gas
平均无故障时间 MTBF	≤100000小时 (h)

端子定义及外形尺寸 Terminal assignments and dimensions

端子 Terminal	接线端子功能定义 Terminal assignments	
14	供电电源+ Power supply +	20~35VDC
15	供电电源- Power supply -	
	二线制 2-wire	电流源 Current source
	三线制 3-wire	
5	输入1+ Input1+	配电电源1+ Provided power supply1+
4	输入1- Input1-	输入1- Input1-
6	输入1+ Input1+	输入1+ Input1+
2	输入2+ Input2+	配电电源2+ Provided power supply2+
1	输入2- Input2-	输入2- Input2-
3	输入2+ Input2+	输入2+ Input2+
8	输出1+ Output1 +	4~20mA
9	输出1- Output1 -	
11	输出2+ Output2+	4~20mA
12	输出2- Output2 -	

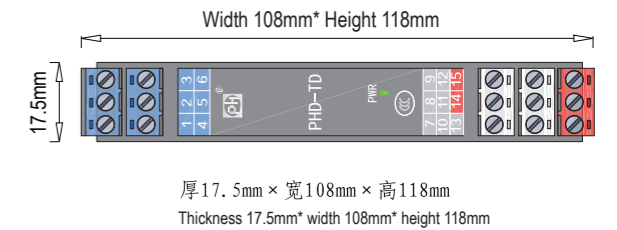

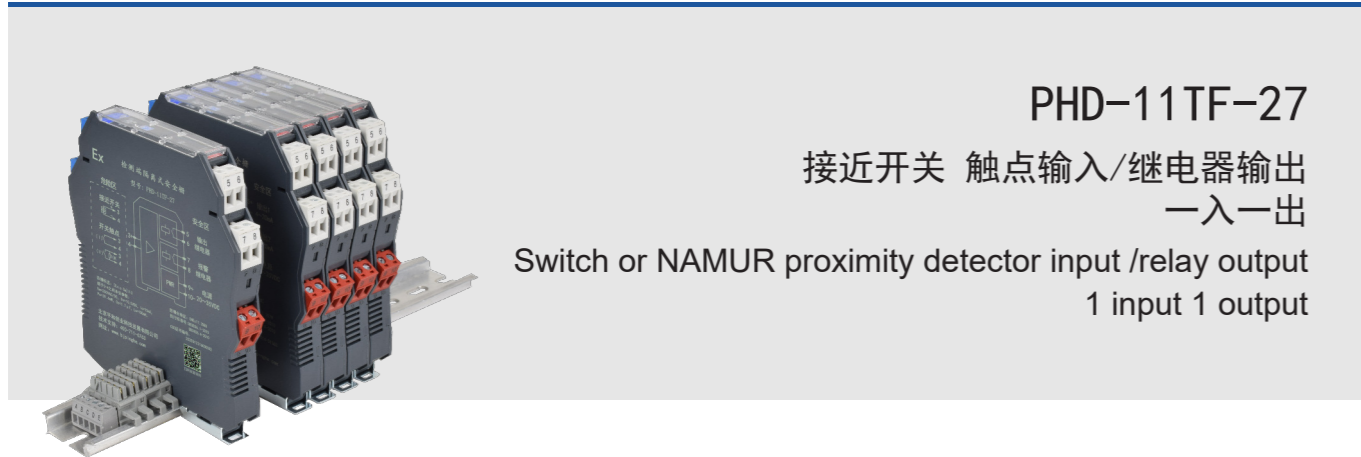

PHD-11TF-27

接近开关 触点输入/继电器输出
一入一出

Switch or NAMUR proximity detector input /relay output
1 input 1 output

概述 Overview

隔离式检测端安全栅：PHD-11TF-27，开关量输入输出，一路输入一路输出。

安全栅可实现将危险区的接近开关、触点输入，转换为继电器触点信号传送到安全区。输出触点设“常开/常闭”状态转换选择开关。另设输入信号短路或开路报警指示，电路为输入端传感器提供电源。

本产品需外接20~35VDC电源。

信号状态指示灯设红黄双色，表示输出继电器工作状态，报警呈现红色，正常工作为黄色。

*总线端子供电，详见附录。

Isolated safety barrier at detection side: PHD-11TF-27, digital input and output, single input and single output.

The isolated barrier can convert the switch or NAMUR proximity detector input in the dangerous area to the relay contact signal and transmit it to the safe area.

The output relay is equipped with selection switch of "ON/OFF" situation. In addition, there is an input signal short-circuit or open-circuit alarm indication, the circuit provides power for the input sensor.

This product needs an external 20~35VDC power supply.

The signal status indicator is set in red and yellow light to indicate the working status of the output relay, when it is for alarming then the light is red, during normal operation the light is yellow.

* Bus power supply, please see appendix for details.

接线图 Wiring diagram

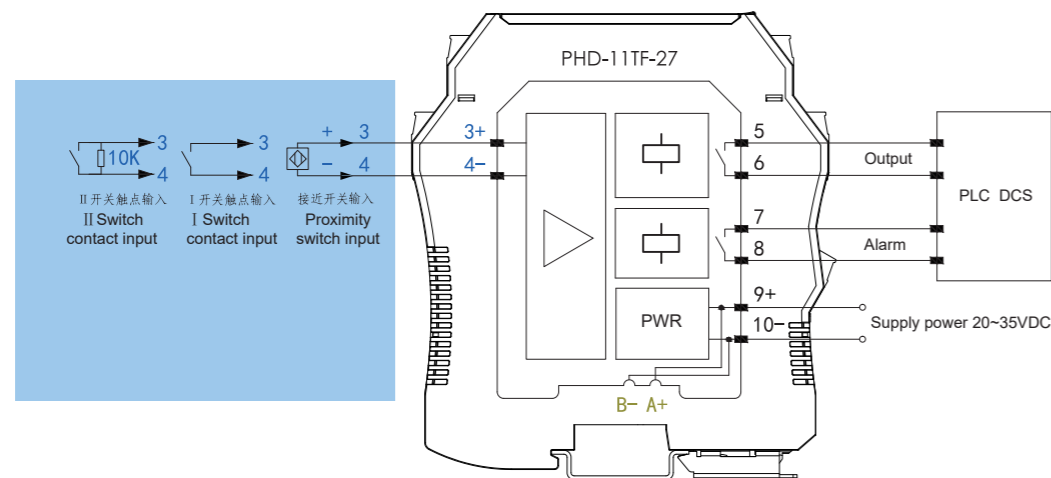

总线供电插接件 可选件 详细说明 见样本后附录
Bus power supply plug connector Optional parts
Detailed description please see appendix

危险区，本安端子：1~4
Hazardous area, intrinsically safe terminals: 1~4

安全区，非本安端子：5~10
Safe area, not intrinsically safe terminals: 5~10

技术数据 Specifications

供电电压 Supply voltage	20~35VDC, 功耗<1.0W 20~35VDC, Power consumption<1.0W
输入信号 Input signal	开关触点/接近开关 Switch or NAMUR proximity detector
现场传感器侧供电电压 Supply voltage of sensor on site	8V
信号输入特性 Signal input characteristics	现场输入电流: >2.1mA时, 表示ON; 现场输入电流: <1.2mA时, 表示OFF On-site input current: >2.1mA, it means ON; On-site input current: <1.2mA, it means OFF 开关滞后作用: 0.2ms Switch hysteresis: 0.2ms
输出及报警继电器特性 Output and alarm relay characteristics	响应时间: 20ms, 驱动能力: 250VAC/2A, 30VDC/2A电阻性负载时 Response time: 20ms, driving capacity: 250VAC/2A, 30VDC/2A under resistive load
输出常开/常闭触点转换控制 Output "ON"/"OFF" contact conversion control	拨码开关K1置“ON”侧, 继电器输出“常闭” When dial switch K1 is at "ON" side, the relay output is "OFF". 拨码开关K1置“OFF”侧, 继电器输出“常开” When dial switch K1 is at "OFF" side, the relay output is "ON". 拨码开关K2置“ON”侧, 电路选用指示灯红灯报警功能 When dial switch K2 is at "ON" side, the circuit selects indicating red light alarm function.
指示灯报警功能 Indicator light alarm function	现场输入电流>7mA, 短路报警 (SC), 现场输入电流<0.1mA, 开路报警 (LB) On-site input current > 7mA, short-circuit alarm (SC), on-site input current < 0.1mA, open-circuit alarm (LB) For switch contact input, when the disconnection detection function is required, a 10KΩ resistor must be connected parallel at both ends of the switch (Please see the switch contact II in the wiring diagram)
输入输出路数 Number of input and output	一路输入, 一路输出 1 input 1 output
适用的现场设备 Applicable field equipments	干触点或符合DIN19234标准的NAMUR型接近开关等 Dry contact or NAMUR proximity switch in accordance with DIN 19234 standard.
温度参数 Temperature parameter	工作温度: -20℃~+60℃, 存储温度: -40℃~+80℃ Working temperature: -20℃~+60℃, storage temperature: -40℃~+80℃
空气相对湿度 Relative humidity	10%~95% RH无凝露 10%~95% RH no condensation
绝缘强度 Dielectric strength	本安端与非本安端 (≥3000VAC/min); 电源与非本安端之间 (≥1500VAC/min) Between intrinsically safe side and non-intrinsically safe side (≥ 3000VAC/min); between power supply and non-intrinsically safe terminal (≥ 1500VAC/min)
绝缘电阻 Insulation resistance	≥100MΩ (输入/输出/电源间) ≥100MΩ (between input/output/power supply)
电磁兼容性 Electromagnetic compatibility	符合IEC 61326-1 (GB/T 18268), IEC 61326-3-1 According to IEC 61326-1 (GB/T 18268), IEC 61326-3-1
防爆标志 Explosion-proof mark	[Exia Ga]IIC
功能安全认证 Functional safety certification	SIL3 符合IEC 61508 EN 61511标准 SIL3 according to IEC 61508 EN 61511 standards
认证机构 Certification Body	国家防爆电气产品质量监督检验中心CQST认证 CQST (China National Quality Supervision and Test Centre for Explosion Protected Electrical Products)
认证参数 (端子3-4之间) Certified parameters (between terminals 3-4)	Um=250V Uo=10.5V Io=15mA Co=1.7μF Lo=150mH Po=39.4mW
安装场所要求 Installation place requirements	可与具有IIA、IIB、IIC危险气体的0区本安仪表相连接 It can be connected with instruments in 0 zone with IIA, IIB, IIC dangerous gas
平均无故障时间 MTBF	≤100000小时 (h)

端子定义及外形尺寸 Terminal assignments and dimensions

端子 Terminal	接线端子功能定义 Terminal assignments
9	供电电源+ Power supply +
10	供电电源- Power supply -
3	输入+ Input+
4	输入- Input-
5	继电器输出 Relay output
6	继电器输出 Relay output
7	报警继电器输出 Alarm relay output
8	报警继电器输出 Alarm relay output

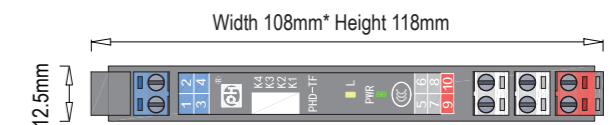

厚12.5mm × 宽108mm × 高118mm
Thickness 12.5mm* width 108mm* height 118mm

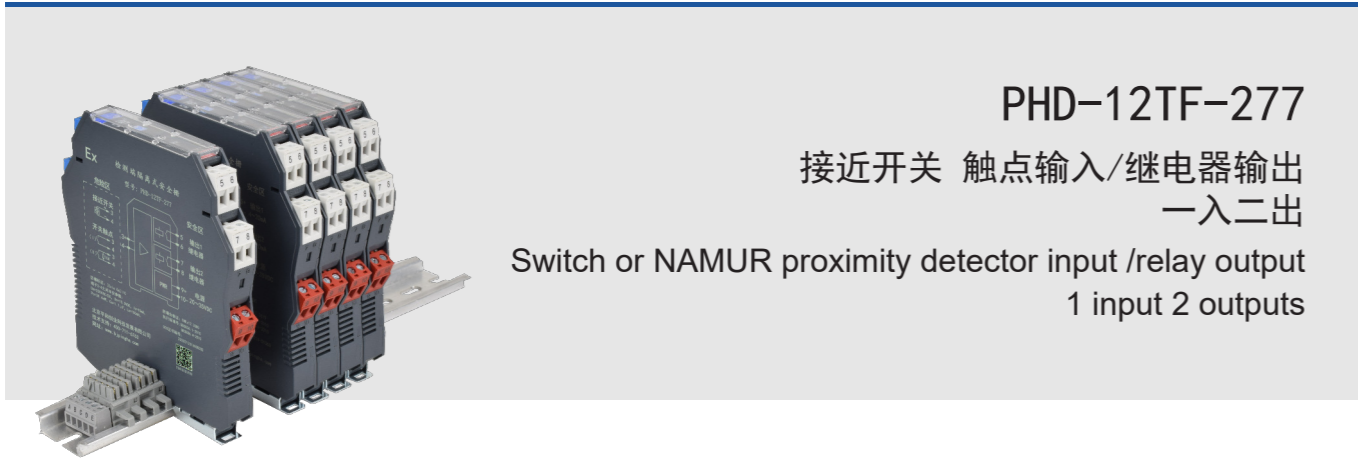

PHD-12TF-277

接近开关 触点输入/继电器输出
一入二出

Switch or NAMUR proximity detector input /relay output
1 input 2 outputs

概述 Overview

隔离式检测端安全栅：PHD-12TF-277，开关量输入输出，一路输入两路输出。

安全栅可实现将危险区的接近开关、触点输入，转换为继电器触点信号传送到安全区。输出触点设“常开/常闭”状态转换选择开关。另设输入信号短路或开路报警指示，电路为输入端传感器提供电源。

本产品需外接20~35VDC电源。

信号状态指示灯设红黄双色，表示输出继电器工作状态，报警呈现红色，正常工作为黄色。

*总线端子供电，详见附录。

Isolated safety barrier at detection side: PHD-12TF-277, digital input and output, single input and dual output.

The isolated barrier can convert the switch or NAMUR proximity detector input in the dangerous area to the relay contact signal and transmit it to the safe area.

The output relay is equipped with selection switch of "ON/OFF" situation. In addition, there is an input signal short-circuit or open-circuit alarm indication, the circuit provides power for the input sensor.

This product needs an external 20~35VDC power supply.

The signal status indicator is set in red and yellow light to indicate the working status of the output relay, when it is for alarming then the light is red, during normal operation the light is yellow.

* Bus power supply, please see appendix for details.

接线图 Wiring diagram

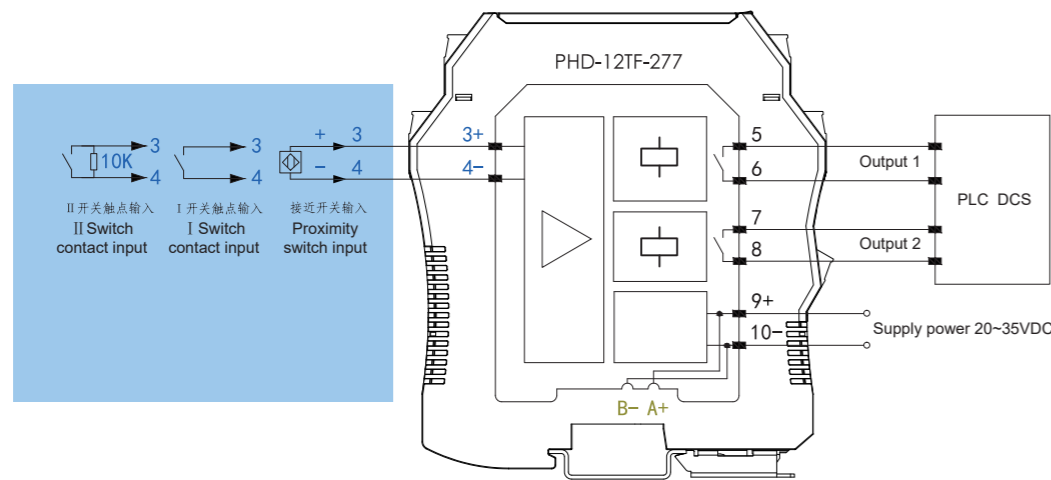

总线供电插接件 可选件 详细说明 见样本后附录
Bus power supply plug connector Optional parts
Detailed description please see appendix

危险区，本安端子：1~4
Hazardous area, intrinsically safe terminals: 1~4

安全区，非本安端子：5~10
Safe area, not intrinsically safe terminals: 5~10

技术数据 Specifications

供电电压 Supply voltage	20~35VDC, 功耗<1.5W 20~35VDC, Power consumption<1.5W
输入信号 Input signal	开关触点/接近开关 Switch or NAMUR proximity detector
现场传感器侧供电电压 Supply voltage of sensor on site	8V
信号输入特性 Signal input characteristics	现场输入电流: >2.1mA时, 表示ON; 现场输入电流: <1.2mA时, 表示OFF On-site input current: >2.1mA, it means ON; On-site input current: <1.2mA, it means OFF 开关滞后作用: 0.2ms Switch hysteresis: 0.2ms
继电器输出特性 Relay output characteristics	响应时间: 20ms, 驱动能力: 250VAC/2A, 30VDC/2A电阻性负载时 Response time: 20ms, driving capacity: 250VAC/2A, 30VDC/2A under resistive load
输出常开/常闭触点转换控制 Output "ON"/"OFF" contact conversion control	拨码开关K1、K3置“ON”侧, 继电器输出“常闭” When the dial switch K1, K3 is at "ON" side, the relay output is "OFF". 拨码开关K1、K3置“OFF”侧, 继电器输出“常开” When the dial switch K1, K3 is at "OFF" side, the relay output is "ON". 拨码开关K2、K4置“ON”侧, 电路选用指示灯红灯报警功能 When the dial switch K2, K4 is at "ON" side, the circuit selects indicating red light alarm function.
指示灯报警功能 Indicator light alarm function	现场输入电流>7mA, 短路报警(SC), 现场输入电流<0.1mA, 开路报警(LB) On-site input current>7mA, short-circuit alarm(SC), on-site input current<0.1mA, open-circuit alarm(LB) 开关触点输入, 需断线检测功能时, 须在开关两端并联10KΩ电阻(如接线图中开关触点II) For switch contact input, when the disconnection detection function is required, a 10KΩ resistor must be connected parallel at both ends of the switch (Please see the switch contact II in the wiring diagram)
输入输出路数 Number of input and output	一路输入, 两路输出 1 input 2 outputs
适用的现场设备 Applicable field equipments	干触点或符合DIN19234标准的NAMUR型接近开关等 Dry contact or NAMUR proximity switch in accordance with DIN 19234 standard.
温度参数 Temperature parameter	工作温度: -20℃~+60℃, 存储温度: -40℃~+80℃ Working temperature: -20℃~+60℃, storage temperature: -40℃~+80℃
空气相对湿度 Relative humidity	10%~95% RH无凝露 10%~95% RH no condensation
绝缘强度 Dielectric strength	本安端与非本安端(≥3000VAC/min); 电源与非本安端之间(≥1500VAC/min) Between intrinsically safe side and non-intrinsically safe side (≥3000VAC/min); between power supply and non-intrinsically safe terminal (≥1500VAC/min)
绝缘电阻 Insulation resistance	≥100MΩ (输入/输出/电源间) ≥100MΩ (between input/output/power supply)
电磁兼容性 Electromagnetic compatibility	符合IEC 61326-1 (GB/T 18268), IEC 61326-3-1 According to IEC 61326-1 (GB/T 18268), IEC 61326-3-1
防爆标志 Explosion-proof mark	[Exia Ga]IIC
功能安全认证 Functional safety certification	SIL3 符合IEC 61508 EN 61511标准 SIL3 according to IEC 61508 EN 61511 standards
认证机构 Certification body	国家防爆电气产品质量监督检验中心CQST认证 CQST (China National Quality Supervision and Test Centre for Explosion Protected Electrical Products)
认证参数 (端子3-4之间) Certified parameters (between terminals 3-4)	Um=250V Uo=10.5V Io=15mA Co=1.7μF Lo=150mH Po=39.4mW
安装场所要求 Installation place requirements	可与具有IIA、IIB、IIC危险气体的0区本安仪表相连接 It can be connected with instruments in 0 zone with IIA, IIB, IIC dangerous gas
平均无故障时间 MTBF	≤100000小时 (h)

端子定义及外形尺寸 Terminal assignments and dimensions

端子 Terminal	接线端子功能定义 Terminal assignments
9	供电电源+ Power supply +
10	供电电源- Power supply -
3	输入+ Input+
4	输入- Input-
5	继电器输出1 Relay output 1
6	继电器输出1 Relay output 1
7	继电器输出2 Relay output 2
8	继电器输出2 Relay output 2

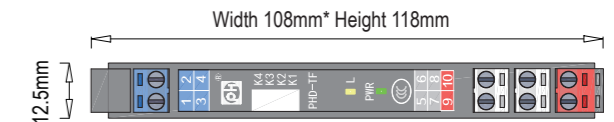

厚12.5mm × 宽108mm × 高118mm
Thickness 12.5mm* width 108mm* height 118mm

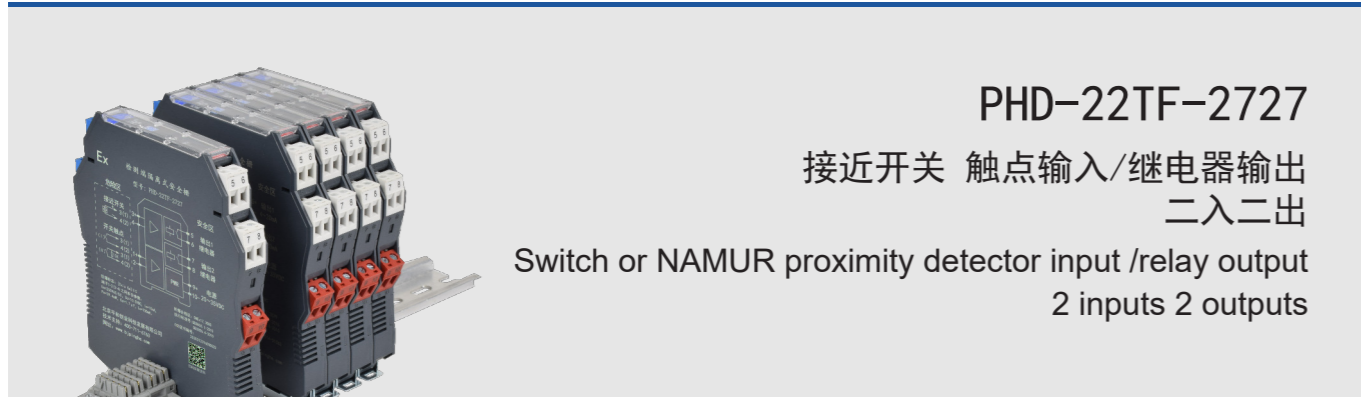

概述 Overview

隔离式检测端安全栅：PHD-22TF-2727，开关量输入输出，两路输入两路输出。

安全栅可实现将危险区的接近开关、触点输入，转换为继电器触点信号传送到安全区。输出触点设“常开/常闭”状态转换选择开关。另设输入信号短路或开路报警指示，电路为输入端传感器提供电源。

本产品需外接20~35VDC电源。

信号状态指示灯设红黄双色，表示输出继电器工作状态，报警呈现红色，正常工作为黄色。

*总线端子供电，详见附录。

Isolated safety barrier at detection side: PHD-22TF-2727, digital input and output, dual input and dual output.

The isolated barrier can convert the switch or NAMUR proximity detector input in the dangerous area to the relay contact signal and transmit it to the safe area.

The output relay is equipped with selection switch of "ON/OFF" situation. In addition, there is an input signal short-circuit or open-circuit alarm indication, the circuit provides power for the input sensor.

This product needs an external 20~35VDC power supply.

The signal status indicator is set in red and yellow light to indicate the working status of the output relay, when it is for alarming then the light is red, during normal operation the light is yellow.

* Bus power supply, please see appendix for details.

接线图 Wiring diagram

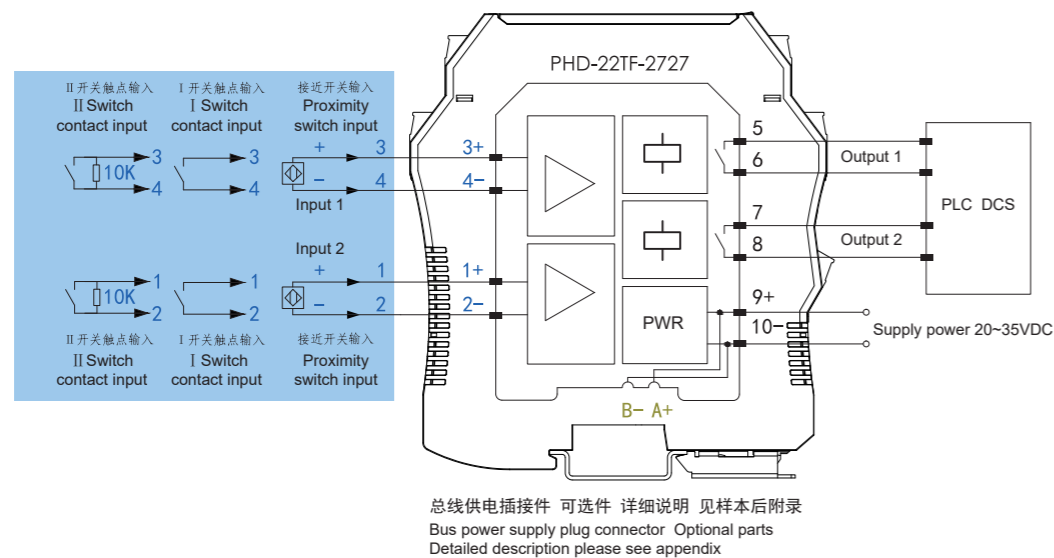

危险区，本安端子：1~4
Hazardous area, intrinsically safe terminals: 1~4

安全区，非本安端子：5~10
Safe area, not intrinsically safe terminals: 5~10

技术数据 Specifications

供电电压 Supply voltage	20~35VDC, 功耗<1.5W 20~35VDC, Power consumption<1.5W
输入信号 Input signal	开关触点/接近开关 Switch or NAMUR proximity detector
现场传感器侧供电电压 Supply voltage of sensor on site	8V
信号输入特性 Signal input characteristics	现场输入电流: >2.1mA时, 表示ON; 现场输入电流: <1.2mA时, 表示OFF On-site input current: >2.1mA, it means ON; On-site input current: <1.2mA, it means OFF 开关滞后作用: 0.2ms Switch hysteresis: 0.2ms
继电器输出特性 Relay output characteristics	响应时间: 20ms, 驱动能力: 250VAC/2A, 30VDC/2A电阻性负载时 Response time: 20ms, driving capacity: 250VAC/2A, 30VDC/2A under resistive load
输出常开/常闭触点转换控制 Output "ON"/"OFF" contact conversion control	拨码开关K1、K3置“ON”侧, 继电器输出“常闭” When the dial switch K1, K3 is at "ON" side, the relay output is "OFF". 拨码开关K1、K3置“OFF”侧, 继电器输出“常开” When the dial switch K1, K3 is at "OFF" side, the relay output is "ON". 拨码开关K2、K4置“ON”侧, 电路选用指示灯红灯报警功能 When the dial switch K2, K4 is at "ON" side, the circuit selects indicating red light alarm function.
指示灯报警功能 Indicator light alarm function	现场输入电流>7mA, 短路报警 (SC), 现场输入电流<0.1mA, 开路报警 (LB) On-site input current >7mA, short-circuit alarm (SC), on-site input current <0.1mA, open-circuit alarm (LB) For switch contact input, when the disconnection detection function is required, a 10KΩ resistor must be connected parallel at both ends of the switch (Please see the switch contact II in the wiring diagram)
输入输出路数 Number of input and output	两路输入, 两路输出 2 inputs 2 outputs
适用的现场设备 Applicable field equipments	干触点或符合DIN19234标准的NAMUR型接近开关等 Dry contact or NAMUR proximity switch in accordance with DIN 19234 standard.
温度参数 Temperature parameter	工作温度: -20℃~+60℃, 存储温度: -40℃~+80℃ Working temperature: -20℃~+60℃, storage temperature: -40℃~+80℃
空气相对湿度 Relative humidity	10%~95% RH无凝露 10%~95% RH no condensation
绝缘强度 Dielectric strength	本安端与非本安端 (≥3000VAC/min); 电源与非本安端之间 (≥1500VAC/min) Between intrinsically safe side and non-intrinsically safe side (≥3000VAC/min); between power supply and non-intrinsically safe terminal (≥1500VAC/min)
绝缘电阻 Insulation resistance	≥100MΩ (输入/输出/电源间) ≥100MΩ (between input/output/power supply)
电磁兼容性 Electromagnetic compatibility	符合IEC 61326-1 (GB/T 18268), IEC 61326-3-1 According to IEC 61326-1 (GB/T 18268), IEC 61326-3-1
防爆标志 Explosion-proof mark	[Exia Ga]IIC
功能安全认证 Functional safety certification	SIL3 符合IEC 61508 EN 61511标准 SIL3 according to IEC 61508 EN 61511 standards
认证机构 Certification body	国家防爆电气产品质量监督检验中心CQST认证 CQST (China National Quality Supervision and Test Centre for Explosion Protected Electrical Products)
认证参数 (端子3-4, 1-2之间) Certified parameters (between terminals 3-4, 1-2)	Um=250V Uo=10.5V Io=15mA Co=1.7μF Lo=150mH Po=39.4mW
安装场所要求 Installation place requirements	可与具有IIA、IIB、IIC危险气体的0区本安仪表相连接 It can be connected with instruments in 0 zone with IIA, IIB, IIC dangerous gas
平均无故障时间 MTBF	≤100000小时 (h)

端子定义及外形尺寸 Terminal assignments and dimensions

端子 Terminal	接线端子功能定义 Terminal assignments
9	供电电源+ Power supply +
10	供电电源- Power supply -
3	输入1+ Input 1+
4	输入1- Input 1-
1	输入2+ Input 2+
2	输入2- Input 2-
5	继电器输出1 Relay output 1
6	继电器输出1 Relay output 1
7	继电器输出2 Relay output 2
8	继电器输出2 Relay output 2

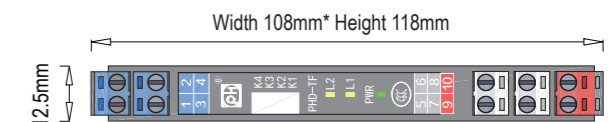

厚12.5mm × 宽108mm × 高118mm
Thickness 12.5mm* width 108mm* height 118mm

Information maybe revised without prior notice

检测端安全栅 Isolated Safety Barrier at Detection Side

Digital Input 开关量输入

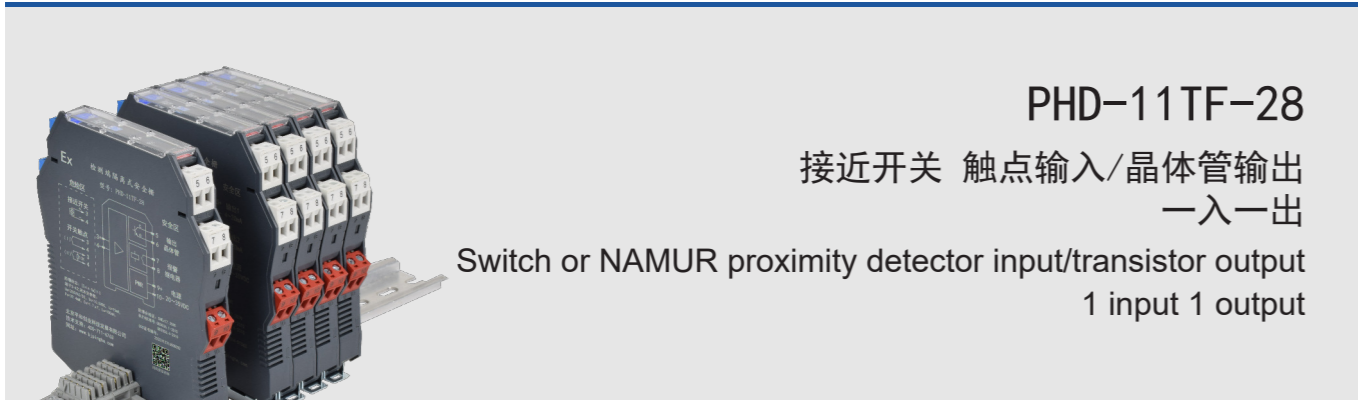

PHD-11TF-28

接近开关 触点输入/晶体管输出
一入一出

Switch or NAMUR proximity detector input/transistor output
1 input 1 output

概述 Overview

隔离式检测端安全栅：PHD-11TF-28，开关量输入输出，一路输入一路输出。

安全栅可实现将危险区的接近开关、触点输入，转换为晶体管输出信号传送到安全区。输出晶体管e-c间设“导通/截止”状态转换选择开关，另设输入信号短路或开路报警指示，电路为输入端传感器提供电源。

本产品需外接20~35VDC电源。

信号状态指示灯设红黄双色，表示输出晶体管工作状态，报警呈现红色，正常工作为黄色。

*总线端子供电，详见附录。

Isolated safety barrier at detection side: PHD-11TF-28, digital input and output, single input and single output.

The isolated barrier can convert the switch or NAMUR proximity detector input in the dangerous area to the transistor output signal and transmit it to the safe area. The output transistor between e-c is equipped with a selection switch of "inverted phase/normal phase", in addition, there is an input signal short circuit or open circuit alarm indicator, the circuit provides for input sensor power supply.

This product needs an external 20~35VDC power supply.

The signal status indicator is set in red and yellow light to indicate the working status of the output transistor, when it is for alarming then the light is red, during normal operation the light is yellow.

* Bus power supply, please see appendix for details.

接线图 Wiring diagram

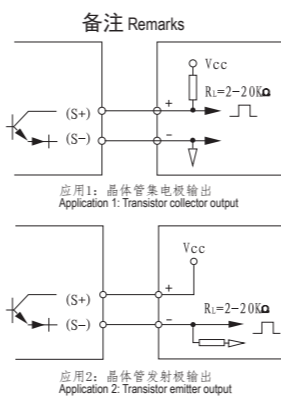
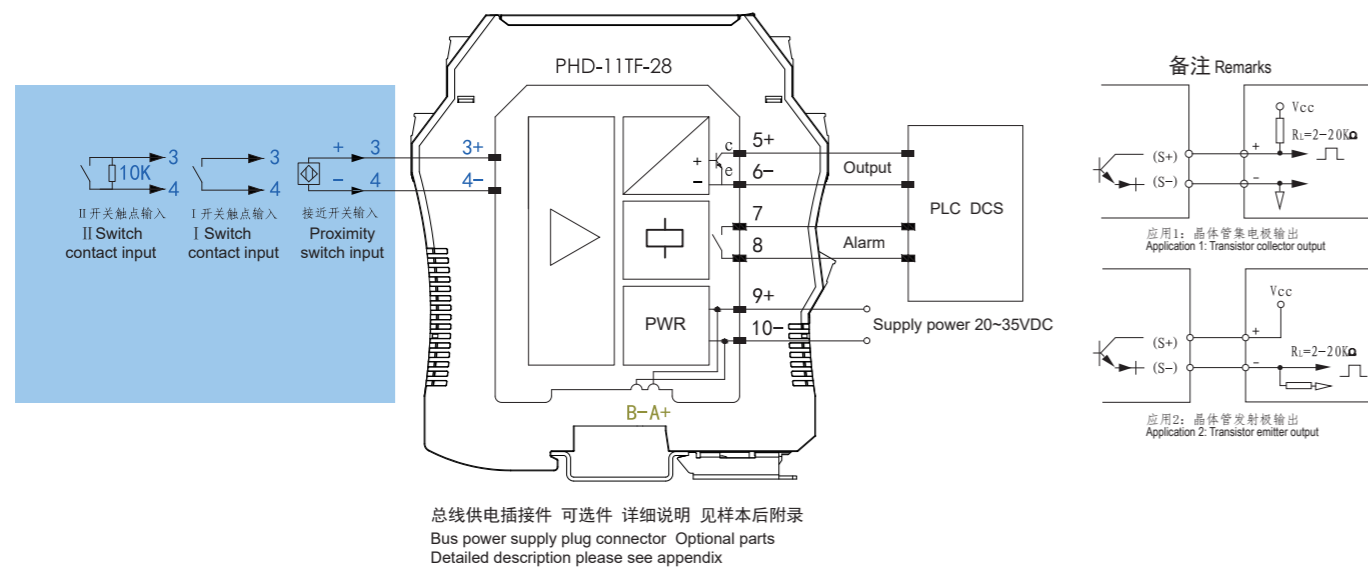

总线供电插接件 可选件 详细说明 见样本后附录
Bus power supply plug connector Optional parts
Detailed description please see appendix

危险区，本安端子：1~4
Hazardous area, intrinsically safe terminals: 1~4

安全区，非本安端子：5~10
Safe area, not intrinsically safe terminals: 5~10

技术数据 Specifications

供电电压 Supply voltage	20~35VDC, 功耗<1.0W 20~35VDC, power consumption<1.0W
输入信号 Input signal	开关触点/接近开关 Switch or NAMUR proximity detector
现场传感器侧供电电压 Supply voltage of sensor on site	8V
信号输入特性 Signal input characteristics	现场输入电流: >2.1mA时, 表示ON; 现场输入电流: <1.2mA时, 表示OFF On-site input current: >2.1mA, it means ON; On-site input current: <1.2mA, it means OFF 开关滞后作用: 0.2ms Switch hysteresis: 0.2ms
晶体管输出特性 Transistor output characteristics	NPN型晶体管发射极或集电极开路输出, 驱动能力: 输出电流≤20mA (1.2KΩ), 内部最大电流100mA, 设短路电流保护 NPN type transistor emitter or collector open circuit output, drive capacity: output current ≤20mA (1.2KΩ), internal maximum current 100mA. Equipped with short-circuit current protection
输出e-c间导通/截止状态可转换控制 Switched control between inverted phase and normal phase of outputs e-c	拨码开关K1置“ON”侧, 晶体管输出e-c间导通 When the dial switch K1 is at "ON", the transistor output e-c are in inverted phase 拨码开关K1置“OFF”侧, 晶体管输出e-c间截止 When the dial switch K1 is at "OFF", the transistor output e-c are in normal phase 拨码开关K2置“ON”侧, 电路选用指示灯红灯报警功能 When the K2 is at "ON", the circuit will select the red light indication alarm function
指示灯报警功能 Indicator light alarm function	现场输入电流>7mA, 短路报警 (SC), 现场输入电流<0.1mA, 开路报警 (LB) On-site input current >7mA, short-circuit alarm (SC), on-site input current <0.1mA, open-circuit alarm (LB) For switch contact input, when the disconnection detection function is required, a 10KΩ resistor must be connected parallel at both ends of the switch (Please see the switch contact II in the wiring diagram)
输入输出路数 Number of input and output	一路输入, 一路输出 1 input 1 output
适用的现场设备 Applicable field equipments	干触点或符合DIN19234标准的NAMUR型接近开关等 Dry contact or NAMUR proximity switch in accordance with DIN 19234 standard.
温度参数 Temperature parameter	连续工作温度: -20℃~+60℃, 存储温度: -40℃~+80℃ continuous in working temperature: -20 C ~+60 C, storage temperature: -40 C ~+80 C
空气相对湿度 Relative humidity	10%~95% RH无凝露 10%~95% RH no condensation
绝缘强度 Dielectric strength	本安端与非本安端 (≥3000VAC/min); 电源与非本安端之间 (≥1500VAC/min) Between intrinsically safe side and non-intrinsically safe side (≥ 3000VAC/min); between power supply and non-intrinsically safe terminal (≥ 1500VAC/min)
绝缘电阻 Insulation resistance	≥100MΩ (输入/输出/电源间) ≥100MΩ (between input/output/power supply)
电磁兼容性 Electromagnetic compatibility	符合IEC 61326-1 (GB/T 18268), IEC 61326-3-1 According to IEC 61326-1 (GB/T 18268), IEC 61326-3-1
防爆标志 Explosion-proof mark	[Exia Ga]IIC
认证机构 Certification body	国家防爆电气产品质量监督检验中心CQST认证 CQST (China National Quality Supervision and Test Centre for Explosion Protected Electrical Products)
认证参数 (端子3-4之间) Certified parameters (between terminals 3-4)	Um=250V Uo=10.5V Io=15mA Co=1.7μF Lo=150mH Po=39.4mW
安装场所要求 Installation place requirements	可与具有IIA、IIB、IIC危险气体的0区本安仪表相连接 It can be connected with instruments in 0 zone with IIA, IIB, IIC dangerous gas
平均无故障时间 MTBF	≤100000小时 (h)

端子定义及外形尺寸 Terminal assignments and dimensions

端子 Terminal	接线端子功能定义 Terminal assignments	
9	供电电源+ Power supply +	20~35VDC
10	供电电源- Power supply -	
3	输入+ Input+	
4	输入- Input-	
5	晶体管输出+ Transistor output+	
6	晶体管输出- Transistor output-	
7	报警继电器输出 Alarm relay output	
8	报警继电器输出 Alarm relay output	

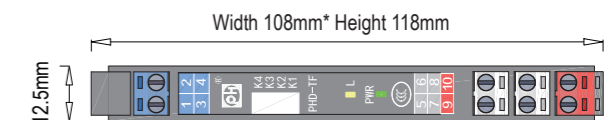

厚12.5mm × 宽108mm × 高118mm
Thickness 12.5mm* width 108mm* height 118mm

检测端安全栅 Isolated Safety Barrier at Detection Side

Digital Input 开关量输入



PHD-12TF-288

接近开关 触点输入/晶体管输出
一入二出

Switch or NAMUR proximity detector input/transistor output
1 input 2 outputs

概述 Overview

隔离式检测端安全栅：PHD-12TF-288，开关量输入输出，一路输入两路输出。

安全栅可实现将危险区的接近开关、触点输入，转换为晶体管输出信号传送到安全区。输出晶体管e-c间设“导通/截止”状态转换选择开关，另设输入信号短路或开路报警指示，电路为输入端传感器提供电源。

本产品需外接20~35VDC电源。

信号状态指示灯设红黄双色，表示输出晶体管工作状态，报警呈现红色，正常工作为黄色。

*总线端子供电，详见附录。

Isolated safety barrier at detection side: PHD-12TF-288, digital input and output, single input and dual output.

The isolated barrier can convert the switch or NAMUR proximity detector input in the dangerous area to the transistor output signal and transmit it to the safe area. The output transistor between e-c is equipped with a selection switch of "inverted phase/normal phase", in addition, there is an input signal short circuit or open circuit alarm indicator, the circuit provides for input sensor power supply.

This product needs an external 20~35VDC power supply.

The signal status indicator is set in red and yellow light to indicate the working status of the output transistor, when it is for alarming then the light is red, during normal operation the light is yellow.

* Bus power supply, please see appendix for details.

接线图 Wiring diagram

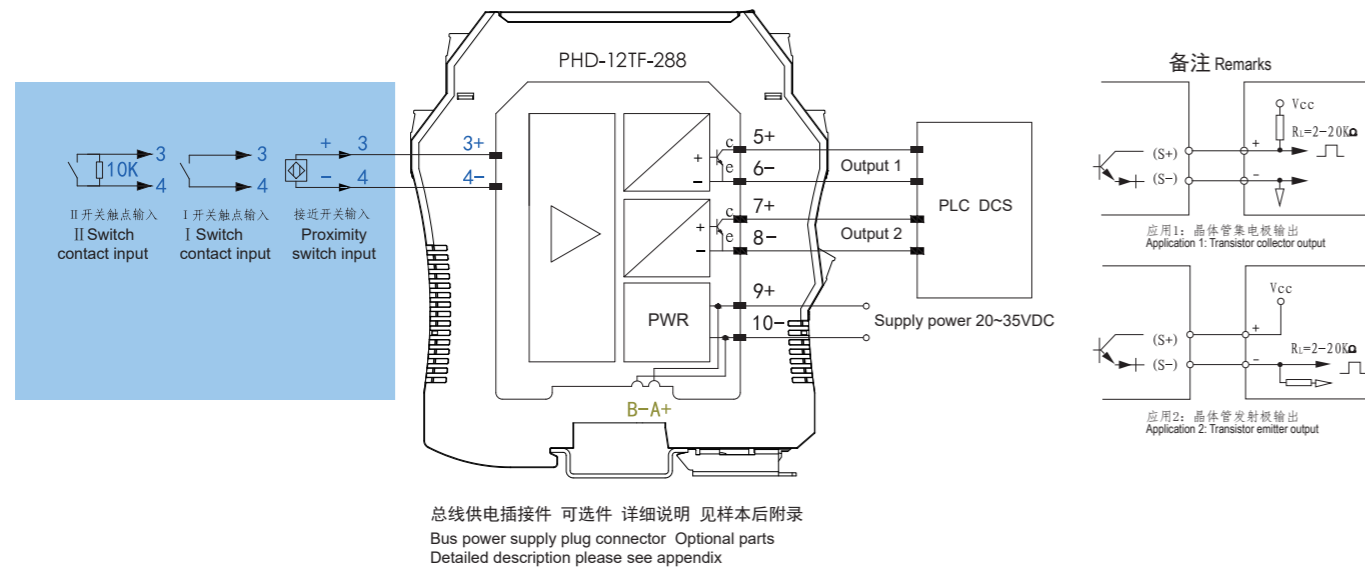

危险区，本安端子：1~4
Hazardous area, intrinsically safe terminals: 1~4

安全区，非本安端子：5~10
Safe area, not intrinsically safe terminals: 5~10

技术数据 Specifications

供电电压 Supply voltage	20~35VDC, 功耗<1.0W 20~35VDC, power consumption<1.0W
输入信号 Input signal	开关触点/接近开关 Switch or NAMUR proximity detector
现场传感器侧供电电压 Supply voltage of sensor on site	8V
信号输入特性 Signal input characteristics	现场输入电流: >2.1mA时, 表示ON; 现场输入电流: <1.2mA时, 表示OFF On-site input current: >2.1mA, it means ON; On-site input current: <1.2mA, it means OFF 开关滞后作用: 0.2ms Switch hysteresis: 0.2ms
晶体管输出特性 Transistor output characteristics	NPN型晶体管发射极或集电极开路输出, 驱动能力: 输出电流≤20mA (1.2KΩ), 内部最大电流100mA, 设短路电流保护 NPN type transistor emitter or collector open circuit output, drive capacity: output current ≤20mA (1.2KΩ), internal maximum current 100mA. Equipped with short-circuit current protection
输出e-c间导通/截止状态可转换控制 Switched control between inverted phase and normal phase of outputs e-c	拨码开关K1置“ON”侧, 晶体管输出e-c间导通 When the dial switch K1 is at "ON", the transistor output e-c are in inverted phase 拨码开关K1置“OFF”侧, 晶体管输出e-c间截止 When the dial switch K1 is at "OFF", the transistor output e-c are in normal phase 拨码开关K2置“ON”侧, 电路选用指示灯红灯报警功能 When the K2 is at "ON", the circuit will select the red light indication alarm function
指示灯报警功能 Indicator light alarm function	现场输入电流>7mA, 短路报警 (SC), 现场输入电流<0.1mA, 开路报警 (LB)。 On-site input current >7mA, short-circuit alarm (SC), on-site input current < 0.1mA, open-circuit alarm (LB) 开关触点输入, 需断线检测功能时, 须在开关两端并联10KΩ电阻 (如接线图中开关触点II) For switch contact input, when the disconnection detection function is required, a 10KΩ resistor must be connected parallel at both ends of the switch (Please see the switch contact II in the wiring diagram)
输入输出路数 Number of input and output	一路输入, 两路输出 1 input 2 outputs
适用的现场设备 Applicable field equipments	干触点或符合DIN19234标准的NAMUR型接近开关等 Dry contact or NAMUR proximity switch in accordance with DIN 19234 standard.
温度参数 Temperature parameter	工作温度: -20℃~+60℃, 存储温度: -40℃~+80℃ Working temperature: -20℃~+60℃, storage temperature: -40℃~+80℃
空气相对湿度 Relative humidity	10%~95% RH无凝露 10%~95% RH no condensation
绝缘强度 Dielectric strength	本安端与非本安端 (≥3000VAC/min); 电源与非本安端之间 (≥1500VAC/min) Between intrinsically safe side and non-intrinsically safe side (≥ 3000VAC/min); between power supply and non-intrinsically safe terminal (≥ 1500VAC/min)
绝缘电阻 Insulation resistance	≥100MΩ (输入/输出/电源间) ≥100MΩ (between input/output/power supply)
电磁兼容性 Electromagnetic compatibility	符合IEC 61326-1 (GB/T 18268), IEC 61326-3-1 According to IEC 61326-1 (GB/T 18268), IEC 61326-3-1
防爆标志 Explosion-proof mark	[Exia Ga]IIC
认证机构 Certification body	国家防爆电气产品质量监督检验中心CQST认证 CQST (China National Quality Supervision and Test Centre for Explosion Protected Electrical Products)
认证参数 (端子3-4之间) Certified parameters (between terminals 3-4)	Um=250V Uo=10.5V Io=15mA Co=1.7μF Lo=150mH Po=39.4mW
安装场所要求 Installation place requirements	可与具有IIA、IIB、IIC危险气体的0区本安仪表相连接 It can be connected with instruments in 0 zone with IIA, IIB, IIC dangerous gas
平均无故障时间 MTBF	≤100000小时 (h)

端子定义及外形尺寸 Terminal assignments and dimensions

端子 Terminal	接线端子功能定义 Terminal assignments
9	供电电源+ Power supply +
10	供电电源- Power supply -
3	输入+ Input+
4	输入- Input-
5	晶体管输出1+ Transistor output 1+
6	晶体管输出1- Transistor output 1-
7	晶体管输出2+ Transistor output 2+
8	晶体管输出2- Transistor output 2-

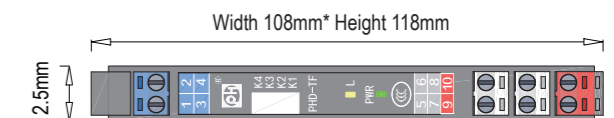

厚12.5mm × 宽108mm × 高118mm
Thickness 12.5mm* width 108mm* height 118mm

Information maybe revised without prior notice

检测端安全栅 Isolated Safety Barrier at Detection Side

Digital Input 开关量输入



PHD-22TF-2828
接近开关 触点输入/晶体管输出
二入二出
Switch or NAMUR proximity detector input/transistor output
2 inputs 2 outputs

概述 Overview

隔离式检测端安全栅：PHD-22TF-2828，开关量输入输出，两路输入两路输出。

安全栅可实现将危险区的接近开关、触点输入，转换为晶体管输出信号传送到安全区。输出晶体管e-c间设“导通/截止”状态转换选择开关，另设输入信号短路或开路报警指示，电路为输入端传感器提供电源。

本产品需外接20~35VDC电源。

信号状态指示灯设红黄双色，表示输出晶体管工作状态，报警呈现红色，正常作为黄色。

*总线端子供电，详见附录。

Isolated safety barrier at detection side: PHD-22TF-2828, digital input and output, dual input and dual output.

The isolated barrier can convert the switch or NAMUR proximity detector input in the dangerous area to the transistor output signal and transmit it to the safe area. The output transistor between e-c is equipped with a selection switch of "inverted phase/normal phase", in addition, there is an input signal short circuit or open circuit alarm indicator, the circuit provides for input sensor power supply.

This product needs an external 20~35VDC power supply.

The signal status indicator is set in red and yellow light to indicate the working status of the output transistor, when it is for alarming then the light is red, during normal operation the light is yellow.

* Bus power supply, please see appendix for details.

接线图 Wiring diagram

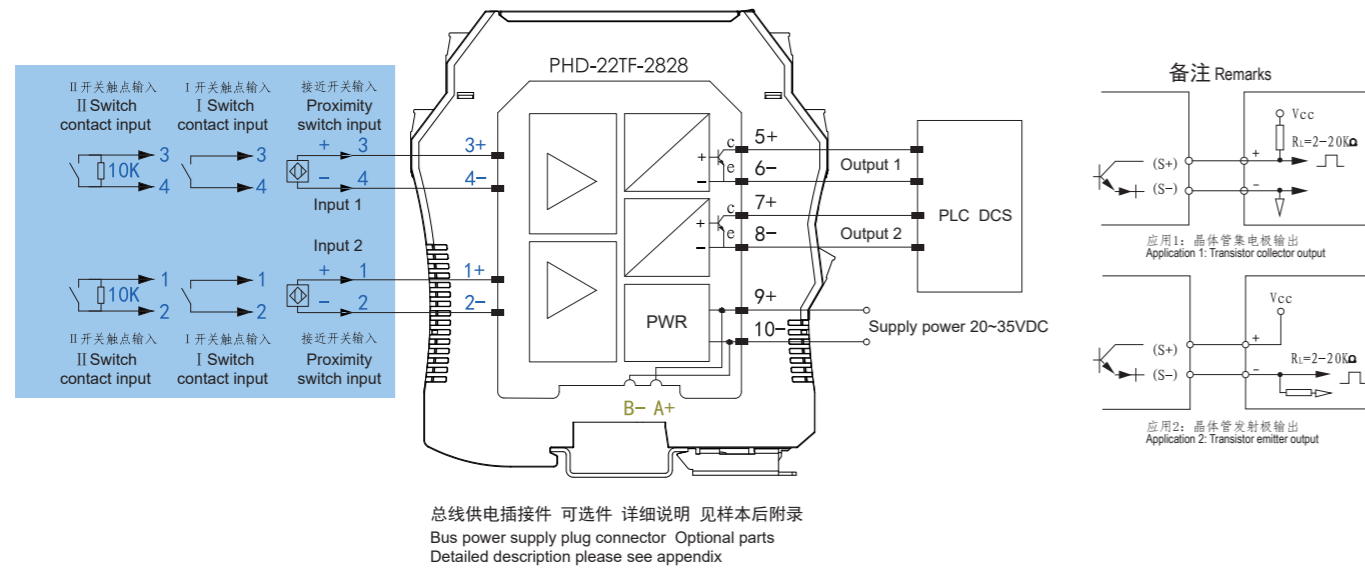

危险区，本安端子：1~4
Hazardous area, intrinsically safe terminals: 1~4

安全区，非本安端子：5~10
Safe area, not intrinsically safe terminals: 5~10

技术数据 Specifications

供电电压 Supply voltage	20~35VDC, 功耗<1.0W 20~35VDC, power consumption<1.0W
输入信号 Input signal	开关触点/接近开关 Switch or NAMUR proximity detector
现场传感器侧供电电压 Supply voltage of sensor on site	8V
信号输入特性 Signal input characteristics	现场输入电流: >2.1mA时, 表示ON; 现场输入电流: <1.2mA时, 表示OFF On-site input current: >2.1mA, it means ON; On-site input current: <1.2mA, it means OFF 开关滞后作用: 0.2ms Switch hysteresis: 0.2ms
晶体管输出特性 Transistor output characteristics	NPN型晶体管发射极或集电极开路输出, 驱动能力: 输出电流≤20mA (1.2KΩ), 内部最大电流100mA, 设短路电流保护 NPN type transistor emitter or collector open circuit output, drive capacity: output current ≤20mA (1.2KΩ), internal maximum current 100mA, Equipped with short-circuit current protection
输出e-c间导通/截止状态可转换控制 Switched control between inverted phase and normal phase of outputs e-c	拨码开关K1、K3置“ON”侧, 晶体管输出e-c间导通 When the dial switch K1, K3 is at "ON", the transistor output e-c are in inverted phase 拨码开关K1、K3置“OFF”侧, 晶体管输出e-c间截止 When the dial switch K1, K3 is at "OFF", the transistor output e-c are in normal phase 拨码开关K2、K4置“ON”侧, 电路选用指示灯红灯报警功能 When the K2, K4 is at "ON", the circuit will select the red light indication alarm function
指示灯报警功能 Indicator light alarm function	现场输入电流>7mA, 短路报警 (SC), 现场输入电流<0.1mA, 开路报警 (LB) On-site input current >7mA, short-circuit alarm (SC), on-site input current <0.1mA, open-circuit alarm (LB) 开关触点输入, 需断线检测功能时, 须在开关两端并联10KΩ电阻 (如下图接线图中开关触点II) For switch contact input, when the disconnection detection function is required, a 10KΩ resistor must be connected parallel at both ends of the switch (Please see the switch contact II in the below wiring diagram)
输入输出路数 Number of input and output	两路输入, 两路输出 2 inputs 2 outputs
适用的现场设备 Applicable field equipments	干触点或符合DIN19234标准的NAMUR型接近开关等 Dry contact or NAMUR proximity switch in accordance with DIN 19234 standard.
温度参数 Temperature parameter	工作温度: -20℃~+60℃, 存储温度: -40℃~+80℃ Working temperature: -20℃~+60℃, storage temperature: -40℃~+80℃
空气相对湿度 Relative humidity	10%~95% RH无凝露 10%~95% RH no condensation
绝缘强度 Dielectric strength	本安端与非本安端 (≥3000VAC/min); 电源与非本安端之间 (≥1500VAC/min) Between intrinsically safe side and non-intrinsically safe side (≥3000VAC/min); between power supply and non-intrinsically safe terminal (≥1500VAC/min)
绝缘电阻 Insulation resistance	≥100MΩ (输入/输出/电源间) ≥100MΩ (between input/output/power supply)
电磁兼容性 Electromagnetic compatibility	符合IEC 61326-1 (GB/T 18268), IEC 61326-3-1 According to IEC 61326-1 (GB/T 18268), IEC 61326-3-1
防爆标志 Explosion-proof mark	[Exia Ga]IIC
认证机构 Certification body	国家防爆电气产品质量监督检验中心CQST认证 CQST (China National Quality Supervision and Test Centre for Explosion Protected Electrical Products)
认证参数 (端子1-2, 3-4之间) Certified parameters (between terminals 1-2, 3-4)	Um=250V Uo=10.5V Io=15mA Co=1.7μF Lo=150mH Po=39.4mW
安装场所要求 Installation place requirements	可与具有IIA、IIB、IIC危险气体的0区本安仪表相连接 It can be connected with instruments in 0 zone with IIA, IIB, IIC dangerous gas
平均无故障时间 MTBF	≤100000小时 (h)

端子定义及外形尺寸 Terminal assignments and dimensions

端子 Terminal	接线端子功能定义 Terminal assignments
9	供电电源+ Power supply +
10	供电电源- Power supply -
3	输入1+ Input 1+
4	输入1- Input 1-
1	输入2+ Input 2+
2	输入2- Input 2-
5	晶体管输出1+ Transistor output 1+
6	晶体管输出1- Transistor output 1-
7	晶体管输出2+ Transistor output 2+
8	晶体管输出2- Transistor output 2-



厚12.5mm × 宽108mm × 高118mm
Thickness 12.5mm* width 108mm* height 118mm

Information maybe revised without prior notice

Beijing Pinghe Chuangye Technology Development Co.,Ltd.
Tel: 8615501038744
Fax: 010-61259872-8027
www.bjpinghe.com

Beijing Pinghe Chuangye Technology Development Co.,Ltd.
Tel: 8615501038744
Fax: 010-61259872-8027
www.bjpinghe.com

北京平和
Bei Jing Ping He

北京平和
Bei Jing Ping He

Information maybe revised without prior notice
Beijing Pinghe Chuangye Technology Development Co.,Ltd.
Tel: 8615501038744
Fax: 010-61259872-8027
www.bjpinghe.com

Beijing Pinghe Chuangye Technology Development Co.,Ltd.
Tel: 8615501038744
Fax: 010-61259872-8027
www.bjpinghe.com



PHD-11TZ-*1
热电阻输入/4~20mA输出 (可组态)
一入一出
RTD input/ 4~20mA output (configurable)
1 input 1 output

概述 Overview

隔离式检测端安全栅：PHD-11TZ-*1，热电阻信号输入，一路输入一路输出。
安全栅可实现将危险区的热电阻信号输入，转换为4~20mA信号输出传送到安全区。电路设一路热电阻信号输入，一路直流信号输出。
输出4~20mA信号，可智能组态，热电阻的实际量程范围可通过计算机进行设定。
PHD-11TZ-*1，“*”表示热电阻的输入类型，请用代码表示。本产品需外接20~35VDC电源。

Isolated safety barrier: PHD-11TZ-*1, RTD signal input, one input and one output. The isolated safety barrier can convert the RTD input signal in hazardous area to 4~20mA signal output and transmit it to the safe area. The circuit is equipped with single RTD signal input and DC signal output. The output 4~20mA signal, can be intelligently configured. The actual range of RTD can be set by computer. PHD-11TZ-*1, "*" indicates the input type of RTD, please use the code to indicate. This product needs an external 20~35VDC power supply.

输入信号类型和量程表 Input signal types and measurement range				
代码 Code	热电阻型号 RTD model	测量范围 Measurement range	最小量程 Minimum range	转换精度 Conversion accuracy
1	G53	-50 ~ 150℃	20℃	0.2℃/0.1%
2	Cu50	-50 ~ 150℃	20℃	0.2℃/0.1%
4	Pt100	-200 ~ 850℃	20℃	0.2℃/0.1%
6	Pt1000	-200 ~ 850℃	20℃	0.2℃/0.1%
7	Ni1000	-60 ~ 250℃	20℃	0.2℃/0.1%

例：检测端安全栅Pt100输入，温度范围0~400℃，输出一路4~20mA，电源20~35VDC。型号为PHD-11TZ-41(0~400℃)，量程范围可通过计算机设定为指定的0~400℃范围。
*总线端子供电，详见附录。

Example: Isolated safety barrier Pt100 input, temperature range 0~400℃, with one output 4~20mA, power supply is 20~35VDC, the model is PHD-11TZ-41 (0~400℃), the measurement range can be set to the specified range of 0~400℃ by computer.
* Bus terminal power supply, please see appendix for details.

接线图 Wiring diagram

- 注：1、三线制热电阻输入时，要尽可能保证三根导线等长。
2、二线制热电阻输入时，安全栅端子4和2必须短接。

Note: 1. When the input is with three-wire thermal resistance, it is better to ensure that the length of the three wires should be equal as much as possible.
2. When the input is with two-wire thermal resistance, terminals 4 and 2 of safety barrier must be shorted connected.

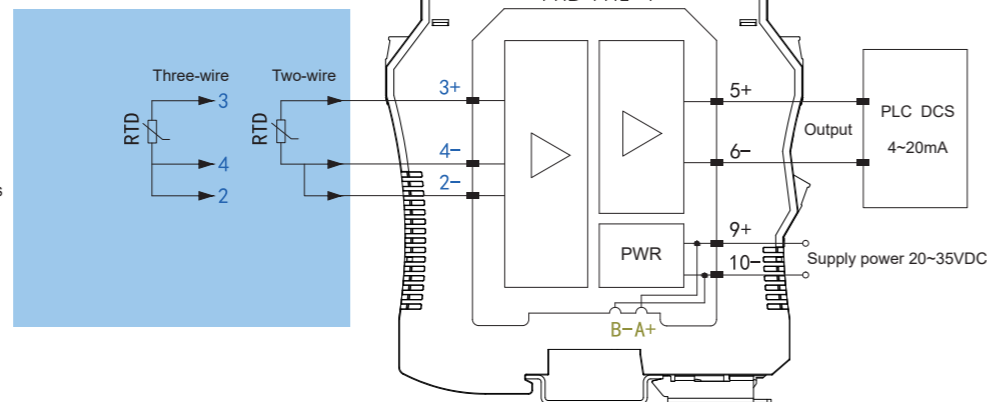

总线供电插接件 可选件 详细说明 见样本后附录
Bus power supply plug connector Optional parts Detailed description please see appendix

危险区，本安端子：1~4
Hazardous area, intrinsically safe terminals: 1~4

安全区，非本安端子：5~10
Safe area, not intrinsically safe terminals: 5~10

技术数据 Specifications

供电电压 Supply voltage	20~35VDC, 功耗<1.2W (24VDC供电, 20mA输出时) 20~35VDC, power consumption<1.2W (when power supply 24VDC, output 20mA)
输入信号 Input signal	二线制或三线制热电阻 Two-wire or three-wire RTD
输出信号 Output signal	4~20mA
信号范围及量程范围 Signal and measurement range	信号范围：对应热电阻的测量范围 Signal range: corresponding to the measurement range of RTD 量程范围：用户订货时自行制定组态，在尾号指明或另说明 Measurement range: When make an order, the user shall make the configuration by himself, which shall be indicated in the tail number or extra explained.
允许输出负载能力 Allowable output load capacity	0~500Ω (可定制) 0~500Ω (customizable)
报警指示 Alarm indication	低量程报警L1灯亮；高量程报警L2灯亮 L1 light is on at low-measurement range alarm; L2 light is on at high-measurement range alarm
输入输出路数 Channel number of input and output	一路输入，一路输出 1 input 1 output
适用的现场设备 Applicable field devices	二线制或三线制热电阻G53, Cu50, Pt100, Pt1000, Ni1000 2-wire or 3-wire RTD G53, Cu50, Pt100, Pt1000, Ni1000
输出精度 Output accuracy	见上页“输入信号类型和量程表” Please see the "Input signal types and measurement table" in above page
温度漂移 Temperature drift	0.005%F. S/℃
温度参数 Temperature parameters	工作温度：-20℃~+60℃，存储温度：-40℃~+80℃ Working temperature: -20℃~+60℃, storage temperature: -40℃~+80℃
空气相对湿度 Relative humidity	10%~95%RH无凝露 10%~95% RH no condensation
绝缘强度 Dielectric strength	本安端与非本安端 (≥3000VAC/min)；电源与非本安端之间 (≥1500VAC/min) Between intrinsically safe side and non-intrinsically safe side (≥ 3000VAC/min); between power supply and non-intrinsically safe terminal (≥ 1500VAC/min)
绝缘电阻 Insulation resistance	≥100MΩ (输入/输出/电源间) ≥100MΩ (between input/output/power supply)
电磁兼容性 Electromagnetic compatibility	符合IEC 61326-1 (GB/T 18268), IEC 61326-3-1 According to IEC 61326-1 (GB/T 18268), IEC 61326-3-1
防爆标志 Explosion-proof mark	[Exia Ga] IIC
认证机构 Certification body	国家防爆电气产品质量监督检验中心CQST认证 CQST (China National Quality Supervision and Test Centre for Explosion Protected Electrical Products)
认证参数 (端子2-3-4之间) Certified parameters (between terminals 2-3-4)	Um=250V Uo=8.4V Io=31mA Co=4.8μF Lo=20mH Po=65mW
安装场所要求 Installation place requirements	可与具有IIA、IIB、IIC危险气体的0区本安仪表相连接 It can be connected with instruments in 0 zone with IIA, IIB, IIC dangerous gas
平均无故障时间 MTBF	≤100000小时 (h)

端子定义及外形尺寸 Terminal assignments and dimensions

端子 Terminal	接线端子功能定义 Terminal assignments	
9	供电电源+ Power supply +	20~35VDC
10	供电电源- Power supply -	
	二线制 2-wire	三线制 3-wire
2	与4短接 with 4 short connected	输入- Input-
3	输入+ Input+	输入+ Input+
4	输入- Input-	输入- Input-
5	输出+ Output+	4~20mA
6	输出- Output-	

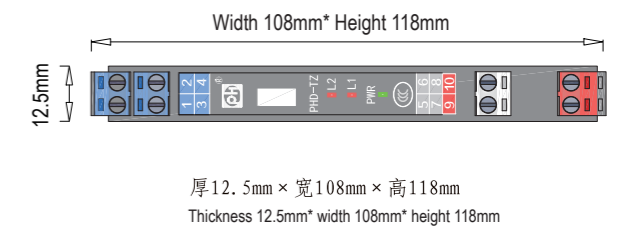

Information maybe revised without prior notice

Beijing Pinghe Chuangye Technology Development Co.,Ltd.
Fax: 010-61259872-8027 www.bjpinghe.com

Tel: 8615501038744
E-mail: quxiaochen@bjpinghe.com

Information maybe revised without prior notice

Beijing Pinghe Chuangye Technology Development Co.,Ltd.
Fax: 010-61259872-8027 www.bjpinghe.com

Tel: 8615501038744
E-mail: quxiaochen@bjpinghe.com



PHD-12TZ-*11
热电阻输入/4~20mA输出 (可组态)
一入二出
RTD input/ 4~20mA output (configurable)
1 input 2 outputs

概述 Overview

隔离式检测端安全栅：PHD-12TZ-*11，热电阻信号输入，一路输入两路输出。
安全栅可实现将危险区的热电阻信号输入，转换为4~20mA信号输出传送到安全区。电路设一路热电阻信号输入，二路直流信号输出。
输出4~20mA信号，可智能组态，热电阻的实际量程范围可通过计算机进行设定。
PHD-12TZ-*11，“*”表示热电阻的输入类型，请用代码表示。本产品需外接20~35VDC电源。

Isolated safety barrier: PHD-12TZ-*11, RTD signal input, single input and dual output.
The isolated safety barrier can convert the RTD input signal in hazardous area to 4~20mA signal output and transmit it to the safe area. The circuit is equipped with single RTD signal input and DC dual output.
The output 4~20mA signal, can be intelligently configured. The actual range of RTD can be set by computer.
PHD-12TZ-*11, "*" indicates the input type of RTD, please use the code to indicate.
This product needs an external 20~35VDC power supply.

输入信号类型和量程表

代码 Code	热电阻型号 RTD model	测量范围 Measurement range	最小量程 Minimum range	转换精度 Conversion accuracy
1	G53	-50 ~ 150℃	20℃	0.2℃/0.1%
2	Cu50	-50 ~ 150℃	20℃	0.2℃/0.1%
4	Pt100	-200 ~ 850℃	20℃	0.2℃/0.1%
6	Pt1000	-200 ~ 850℃	20℃	0.2℃/0.1%
7	Ni1000	-60 ~ 250℃	20℃	0.2℃/0.1%

例：检测端安全栅Pt100输入，温度范围0~400℃，输出二路4~20mA，电源20~35VDC。型号为PHD-12TZ-411(0~400℃)，量程范围可通过计算机设定为指定的0~400℃范围。
*总线端子供电，详见附录。

Example: Isolated safety barrier Pt100 input, temperature range 0~400℃, with two outputs 4~20mA, power supply 20~35VDC, the model is PHD-12TZ-411 (0~400℃), the measurement range can be set to the specified range of 0~400℃ by computer
* Bus terminal power supply, please see appendix for details.

接线图 Wiring diagram

- 注：1、三线制热电阻输入时，要尽可能保证三根导线等长。
2、二线制热电阻输入时，安全栅端子4和2必须短接。
- Note: 1. When the input is with three-wire thermal resistance, it is better to ensure that the length of the three wires should be equal as much as possible.
2. When the input is with two-wire thermal resistance, terminals 4 and 2 of safety barrier must be shorted connected.

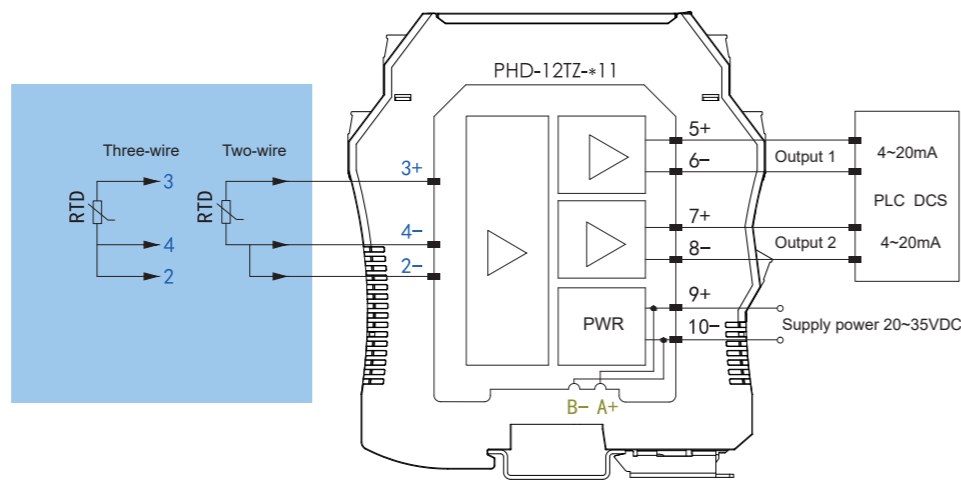

总线供电插接件 可选件 详细说明 见样本后附录
Bus power supply plug connector Optional parts Detailed description please see appendix

危险区，本安端子：1~4
Hazardous area, intrinsically safe terminals: 1~4

安全区，非本安端子：5~10
Safe area, not intrinsically safe terminals: 5~10

技术数据 Specifications

供电电压 Supply voltage	20~35VDC, 功耗<1.8W (24VDC供电, 20mA输出时) 20~35VDC, power consumption<1.8W (when power supply 24VDC, output 20mA)
输入信号 Input signal	二线制或三线制热电阻 Two-wire or three-wire RTD
输出信号 Output signal	4~20mA
信号范围及量程范围 Signal and measurement range	信号范围：对应热电阻的测量范围 Signal range: corresponding to the measurement range of RTD 量程范围：用户订货时自行制定组态，在尾号指明或另说明 Measurement range: When make an order, the user shall make the configuration by himself, which shall be indicated in the tail number or extra explained.
允许输出负载能力 Allowable output load capacity	0~500Ω (可定制) 0~500Ω (customizable)
报警指示 Alarm indication	低量程报警L1灯亮；高量程报警L2灯亮 L1 light is on at low-measurement range alarm; L2 light is on at high-measurement range alarm
输入输出路数 Channel number of input and output	一路输入，两路输出 1 input 2 outputs
适用的现场设备 Applicable field devices	二线制或三线制热电阻G53, Cu50, Pt100, Pt1000, Ni1000 2-wire or 3-wire RTD G53, Cu50, Pt100, Pt1000, Ni1000
输出精度 Output accuracy	见上页“输入信号类型和量程表” Please see the "Input signal types and measurement table" in above page
温度漂移 Temperature drift	0.005%F. S/℃
温度参数 Temperature parameters	工作温度：-20℃~+60℃，存储温度：-40℃~+80℃ Working temperature: -20℃~+60℃, storage temperature: -40℃~+80℃
空气相对湿度 Relative humidity	10%~95%RH无凝露 10%~95% RH no condensation
绝缘强度 Dielectric strength	本安端与非本安端 (≥3000VAC/min)；电源与非本安端之间 (≥1500VAC/min) Between intrinsically safe side and non-intrinsically safe side (≥ 3000VAC/min) ; between power supply and non-intrinsically safe terminal (≥ 1500VAC/min)
绝缘电阻 Insulation resistance	≥100MΩ (输入/输出/电源间) ≥100MΩ (between input/output/power supply)
电磁兼容性 Electromagnetic compatibility	符合IEC 61326-1 (GB/T 18268)，IEC 61326-3-1 According to IEC 61326-1 (GB/T 18268), IEC 61326-3-1
功能安全认证 Functional safety certification	SIL3 符合IEC 61508 EN 61511标准 SIL3 according to IEC 61508 EN 61511 standards
防爆标志 Explosion-proof mark	[Exia Ga] IIC
认证机构 Certification body	国家防爆电气产品质量监督检验中心CQST认证 CQST (China National Quality Supervision and Test Centre for Explosion Protected Electrical Products)
认证参数(端子2-3-4之间) Certified parameters (between terminals 2-3-4)	Um=250V Uo=8.4V Io=31mA Co=4.8μF Lo=20mH Po=65mW
安装场所要求 Installation place requirements	可与具有IIA、IIB、IIC危险气体的0区本安仪表相连接 It can be connected with instruments in 0 zone with IIA, IIB, IIC dangerous gas
平均无故障时间 MTBF	≤100000小时 (h)

端子定义及外形尺寸 Terminal assignments and dimensions

端子 Terminal	接线端子功能定义 Terminal assignments
9	供电电源+ Power supply +
10	供电电源- Power supply -
2	二线制 2-wire
3	与4短接 with 4 short connected
4	输入+ Input+
5	输出1+ Output 1+
6	输出1- Output 1-
7	输出2+ Output 2+
8	输出2- Output 2-

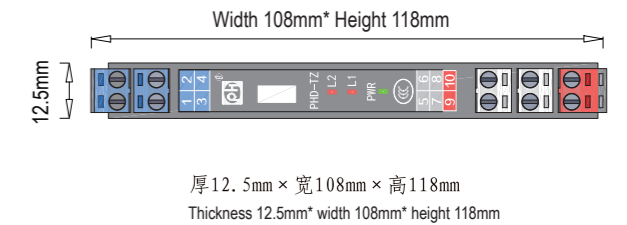

厚12.5mm × 宽108mm × 高118mm
Thickness 12.5mm* width 108mm* height 118mm



PHD-22TZ-*1*1
热电阻输入/4~20mA输出 (可组态)
二入二出
RTD input/ 4~20mA output (configurable)
2 inputs 2 outputs

概述 Overview

隔离式检测端安全栅：PHD-22TZ-*1*1，热电阻信号输入，二路输入二路输出。
安全栅可实现将危险区的热电阻信号输入，转换为4~20mA信号输出传送到安全区。电路设二路热电阻信号输入，二路直流信号输出。
输出4~20mA信号，可智能组态，热电阻的实际量程范围可通过计算机进行设定。
PHD-22TZ-*1*1，“*”表示热电阻的输入类型，请用代码表示。本产品需外接20~35VDC电源。

Isolated safety barrier: PHD-22TZ-*1*1, RTD signal input, dual input and dual output.
The isolated safety barrier can convert the RTD input signal in hazardous area to 4~20mA signal output and transmit it to the safe area. The circuit is equipped with dual RTD signal input and DC dual output.
The output 4~20mA signal, can be intelligently configured. The actual range of RTD can be set by computer.
PHD-22TZ-*1*1, "*" indicates the input type of RTD, please use the code to indicate.
This product needs an external 20~35VDC power supply.

代码 Code	热电阻型号 RTD model	测量范围 Measurement range	最小量程 Minimum range	转换精度 Conversion accuracy
1	G53	-50 ~ 150℃	20℃	0.2℃/0.1%
2	Cu50	-50 ~ 150℃	20℃	0.2℃/0.1%
4	Pt100	-200 ~ 850℃	20℃	0.2℃/0.1%
6	Pt1000	-200 ~ 850℃	20℃	0.2℃/0.1%
7	Ni1000	-60 ~ 250℃	20℃	0.2℃/0.1%

例：检测端安全栅Pt100输入，温度范围0~400℃，输出二路4~20mA，电源20~35VDC。型号为PHD-22TZ-4141(0~400℃)，量程范围可通过计算机设定为指定的0~400℃范围。
*总线端子供电，详见附录。

Example: Isolated safety barrier Pt100 input, temperature range 0~400℃, two outputs are with 4~20mA, the power supply is 20~35VDC. The model is PHD-22TZ-4141(0~400℃), the measurement range can be set to the specified range of 0~400℃ by computer.
* Bus terminal power supply, please see appendix for details.

接线图 Wiring diagram

- 注：1、三线制热电阻输入时，要尽可能保证三根导线等长。
2、二线制热电阻输入时，安全栅端子6和5（2和3）必须短接。
- Note: 1. When the input is with three-wire thermal resistance, it is better to ensure that the length of the three wires should be equal as much as possible.
2. When the input is with two-wire thermal resistance, terminals 6 and 5 (2 and 3) of safety barrier must be shorted connected.

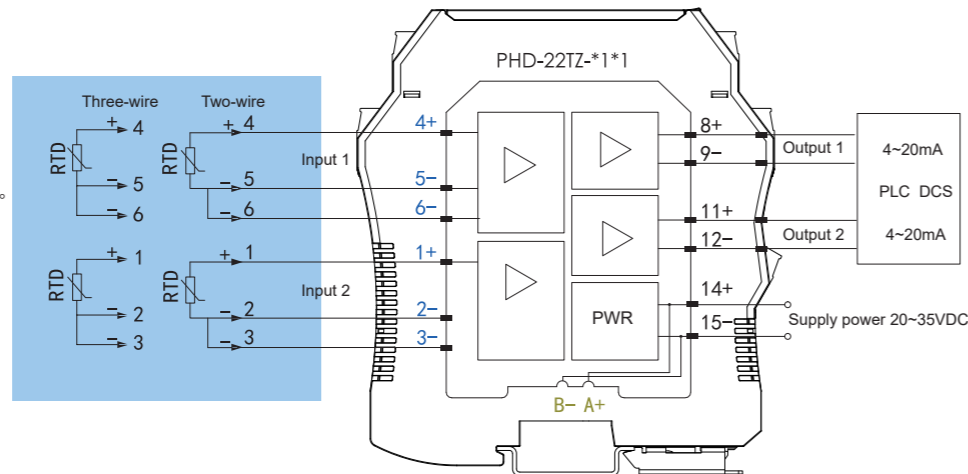

总线供电插接件 可选件 详细说明 见样本后附录
Bus power supply plug connector Optional parts
Detailed description please see appendix

危险区，本安端子：1~6
Hazardous area, intrinsically safe terminals: 1~6

安全区，非本安端子：7~15
Safe area, not intrinsically safe terminals: 7~15

技术数据 Specifications

供电电压 Supply voltage	20~35VDC, 功耗<2W (24VDC供电, 20mA输出时) 20~35VDC, power consumption<2W (when power supply 24VDC, output 20mA)
输入信号 Input signal	二线制或三线制热电阻 Two-wire or three-wire RTD
输出信号 Output signal	4~20mA
信号范围及量程范围 Signal and measurement range	信号范围：对应热电阻的测量范围 Signal range: corresponding to the measurement range of RTD 量程范围：用户订货时自行制定组态，在尾号指明或另说明 Measurement range: When make an order, the user shall make the configuration by himself, which shall be indicated in the tail number or extra explained.
允许输出负载能力 Allowable output load capacity	0~500Ω (可定制) 0~500Ω (customizable)
报警指示 Alarm indication	L1为输入1报警、L2为输入2报警 (低量程黄灯报警, 高量程红灯报警) L1 is for alarm of input 1, L2 for alarm of input 2 (when low measurement range the yellow light make alarm, high measurement range red light makes alarm.)
输入输出路数 Channel number of input and output	二路输入, 二路输出 2 inputs 2 outputs
适用的现场设备 Applicable field devices	二线制或三线制热电阻G53, Cu50, Pt100, Pt1000, Ni1000 2-wire or 3-wire RTD G53, Cu50, Pt100, Pt1000, Ni1000
输出精度 Output accuracy	见上页“输入信号类型和量程表” Please see the "Input signal types and measurement table" in above page
温度漂移 Temperature drift	0.005%F. S/℃
温度参数 Temperature parameters	工作温度：-20℃~+60℃, 存储温度：-40℃~+80℃ Working temperature: -20℃~+60℃, storage temperature: -40℃~+80℃
空气相对湿度 Relative humidity	10%~95%RH无凝露 10%~95%RH no condensation
绝缘强度 Dielectric strength	本安端与非本安端 (≥3000VAC/min); 电源与非本安端之间 (≥1500VAC/min) Between intrinsically safe side and non-intrinsically safe side (≥3000VAC/min); between power supply and non-intrinsically safe terminal (≥1500VAC/min)
绝缘电阻 Insulation resistance	≥100MΩ (输入/输出/电源间) ≥100MΩ (between input/output/power supply)
电磁兼容性 Electromagnetic compatibility	符合IEC 61326-1 (GB/T 18268), IEC 61326-3-1 According to IEC 61326-1 (GB/T 18268), IEC 61326-3-1
防爆标志 Explosion-proof mark	[Exia Ga] IIC
认证机构 Certification Body	国家防爆电气产品质量监督检验中心CQST认证 CQST (China National Quality Supervision and Test Centre for Explosion Protected Electrical Products)
认证参数 (端子4-5-6, 1-2-3之间) Certified parameters (between terminals 2-3-4)	Um=250V Uo=8.4V Io=31mA Co=4.8μF Lo=20mH Po=65mW
安装场所要求 Installation place requirements	可与具有IIA、IIB、IIC危险气体的0区本安仪表相连接 It can be connected with instruments in 0 zone with IIA, IIB, IIC dangerous gas
平均无故障时间 MTBF	≤100000小时 (h)

端子定义及外形尺寸 Terminal assignments and dimensions

端子 Terminal	接线端子功能定义 Terminal assignments
14	供电电源+ Power supply+
15	供电电源- Power supply-
4	二线制 2-wire
5	输入1+ Input 1+
6	与5短接 with 5 short connected
1	输入2+ Input 2+
2	输入2- Input 2-
3	与2短接 with 2 short connected
8	输出1+ Output 1+
9	输出1- Output 1-
11	输出2+ Output 2+
12	输出2- Output 2-

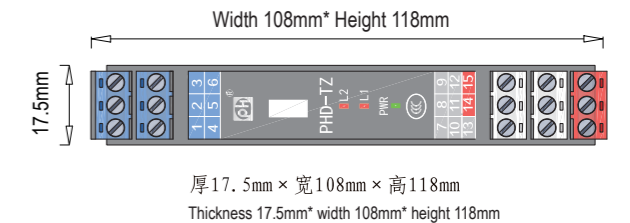

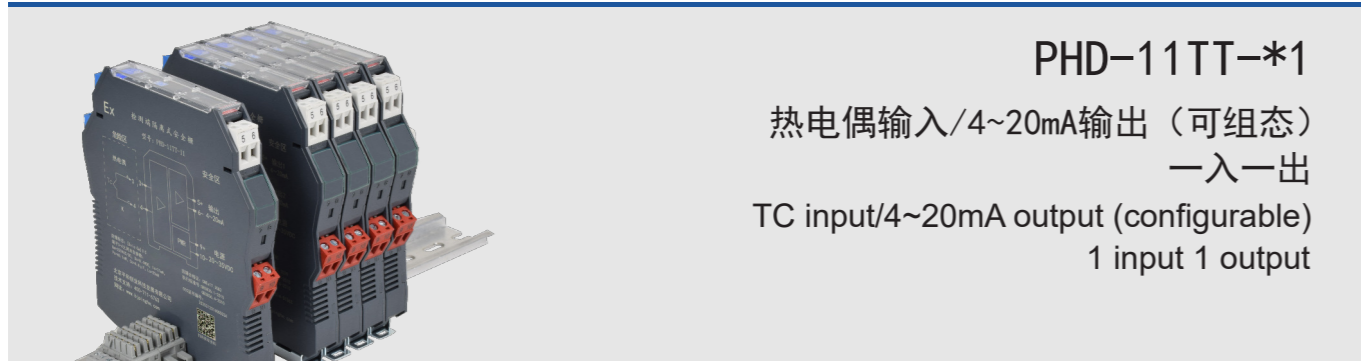

PHD-11TT-*1
 热电偶输入/4~20mA输出 (可组态)
 一入一出
 TC input/4~20mA output (configurable)
 1 input 1 output

概述 Overview

隔离式检测端安全栅: PHD-11TT-*1, 热电偶信号输入, 一路输入一路输出。
 安全栅可实现将危险区的热电偶信号输入, 转换为4~20mA信号输出传送到安全区。电路设一路热电偶信号输入, 一路直流4~20mA信号输出。
 输出4~20mA信号, 可智能组态, 实际量程范围可通过计算机进行设定。
 PHD-11TT-*1, “*”表示热电偶的输入类型, 请用代码表示。本产品需外接20~35VDC电源。

Isolated detection side safety barrier: PHD-11TT-*1, thermocouple signal input, single input and single output, the safety barrier can realize the conversion of thermocouple signal input in dangerous area into 4~20mA signal output and transmit it to safe area. The circuit has one thermocouple input and one DC signal 4~20mA output.
 The output 4~20mA signal can be intelligently configured, and the actual measuring range can be set by computer.
 PHD-11TT-*1, “*” indicates the input type of thermocouple, please use code to indicate it.
 This product needs an external power supply of 20~35VDC

代码 Code	热电偶型号 RTD model	测量范围 Measurement range	最小量程 Minimum range	转换精度 Conversion accuracy
1	K	-200 ~ 1370°C	50°C	0.5°C/0.1%
2	S	-50 ~ 1760°C	500°C	1.5°C/0.1%
3	E	-140 ~ 1000°C	50°C	0.5°C/0.1%
4	J	-160 ~ 1200°C	50°C	0.5°C/0.1%
5	B	250 ~ 1800°C	500°C	1.5°C/0.1%
6	T	-200 ~ 400°C	50°C	0.5°C/0.1%
7	R	-50 ~ 1760°C	500°C	1.5°C/0.1%
8	N	-200 ~ 1300°C	50°C	0.5°C/0.1%

例: 检测端安全栅K偶输入, 温度范围0~1200°C, 输出一路4~20mA信号, 电源20~35VDC。型号为PHD-11TT-11 (0~1200°C), 量程范围可通过计算机设定为指定的0~1200°C范围。
 *总线端子供电, 详见附录。

Example: when the input is with K-couple, temperature range is 0~1200°C, with one output 4~20mA, power supply 20~35VDC, then the model should be PHD-11TT-11 (0~1200°C).
 The measuring range can be set to the specified 0~1200°C range by computer
 * Bus terminal power supply, see appendix for details.

接线图 Wiring diagram

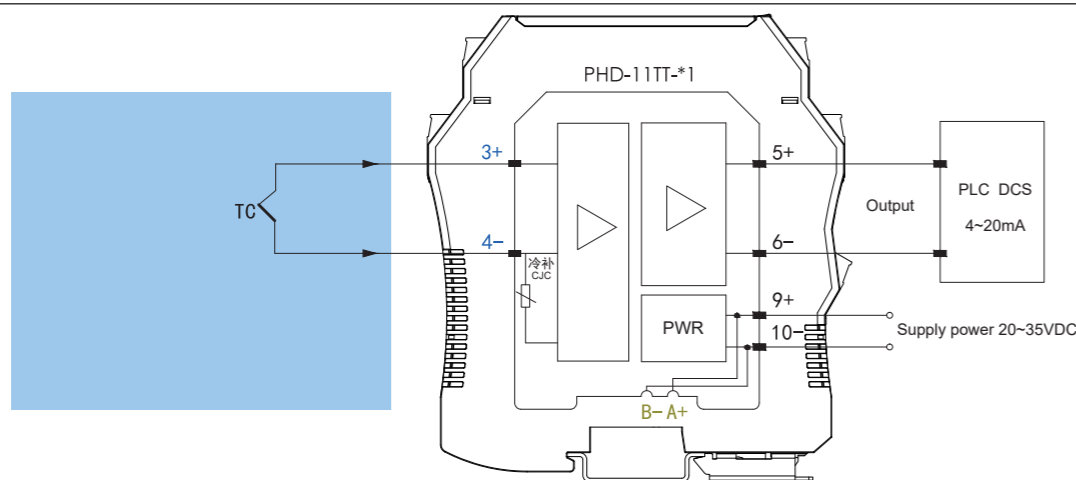

总线供电插接件 可选件 详细说明 见样本后附录
 Bus power supply plug connector Optional parts Detailed description please see appendix

危险区, 本安端子: 1~4
 Hazardous area, intrinsically safe terminals: 1~4

安全区, 非本安端子: 5~10
 Safe area, not intrinsically safe terminals: 5~10

技术数据 Specifications

供电电压 Supply voltage	20~35VDC, 功耗<1.2W (24VDC供电, 20mA输出时) 20~35VDC, power consumption<1.2W (when power supply 24VDC, output 20mA)
输入信号 Input signal	K、S、E、J、B、T、R、N热电偶信号 K, S, E, J, B, T, R, N, TC Signals
输出信号 Output signal	4~20mA
信号范围及量程范围 Signal and measurement range	信号范围: 对应热电偶的测量范围-10~100mV Signal range: corresponding to the measuring range of TC -10~100mV 量程范围: 用户订货时自行制定组态, 在尾号指明或另说明 Measurement range: When make an order, the user shall make the configuration by himself, which shall be indicated in the tail number or extra explained.
允许输出负载能力 Allowable output load capacity	0~500Ω (可定制) 0~500Ω (customizable)
报警指示 Alarm indication	低量程报警L1灯亮; 高量程报警L2灯亮 L1 light is on at low-measurement range alarm; L2 light is on at high-measurement range alarm
输入输出路数 Channel number of input and output	一路输入, 一路输出 1 input 1 output
适用的现场设备 Applicable field devices	K、S、E、J、B、T、R、N热电偶传感器 K, S, E, J, B, T, R, N, TC sensors
输出精度 Output accuracy	见上页“输入信号类型和量程表” Please see the "Input signal types and measurement table" in above page
冷端补偿 Cold junction compensation	±1°C (补偿范围-20°C~+60°C) ±1°C (Compensation range -20°C~+60°C)
温度漂移 Temperature drift	0.005%F.S/°C
温度参数 Temperature parameters	工作温度: -20°C~+60°C, 存储温度: -40°C~+80°C Working temperature: -20°C~+60°C, storage temperature: -40°C~+80°C
空气相对湿度 Relative humidity	10%~95%RH无凝露 10%~95%RH no condensation
绝缘强度 Dielectric strength	本安端与非本安端 (≥3000VAC/min); 电源与非本安端之间 (≥1500VAC/min) Between intrinsically safe side and non-intrinsically safe side (≥3000VAC/min); between power supply and non-intrinsically safe terminal (≥1500VAC/min)
绝缘电阻 Insulation resistance	≥100MΩ (输入/输出/电源间) ≥100MΩ (between input/output/power supply)
电磁兼容性 Electromagnetic compatibility	符合IEC 61326-1 (GB/T 18268), IEC 61326-3-1 According to IEC 61326-1 (GB/T 18268), IEC 61326-3-1
防爆标志 Explosion-proof mark	[Exia Ga]IIC
认证机构 Certification Body	国家防爆电气产品质量监督检验中心CQST认证 CQST (China National Quality Supervision and Test Centre for Explosion Protected Electrical Products)
认证参数 (端子3-4之间) Certified parameters (between terminals 3-4)	Um=250V Uo=8.4V Io=31mA Co=4.8μF Lo=20mH Po=65mW
安装场所要求 Installation place requirements	可与具有IIA、IIB、IIC危险气体的0区本安仪表相连接 It can be connected with instruments in 0 zone with IIA, IIB, IIC dangerous gas
平均无故障时间 MTBF	≤100000小时 (h)

端子定义及外形尺寸 Terminal assignments and dimensions

端子 Terminal	接线端子功能定义 Terminal assignments	
9	供电电源+ Power supply +	20~35VDC
10	供电电源- Power supply -	
3	输入+ Input+	TC
4	输入- Input-	
5	输出+ Output+	4~20mA
6	输出- Output-	

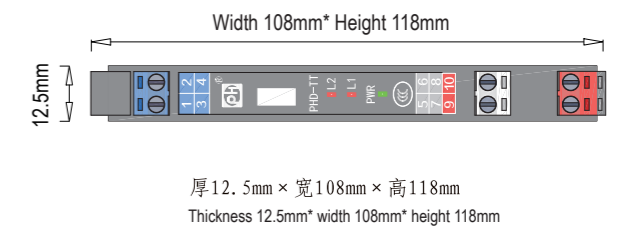

厚12.5mm × 宽108mm × 高118mm
 Thickness 12.5mm* width 108mm* height 118mm

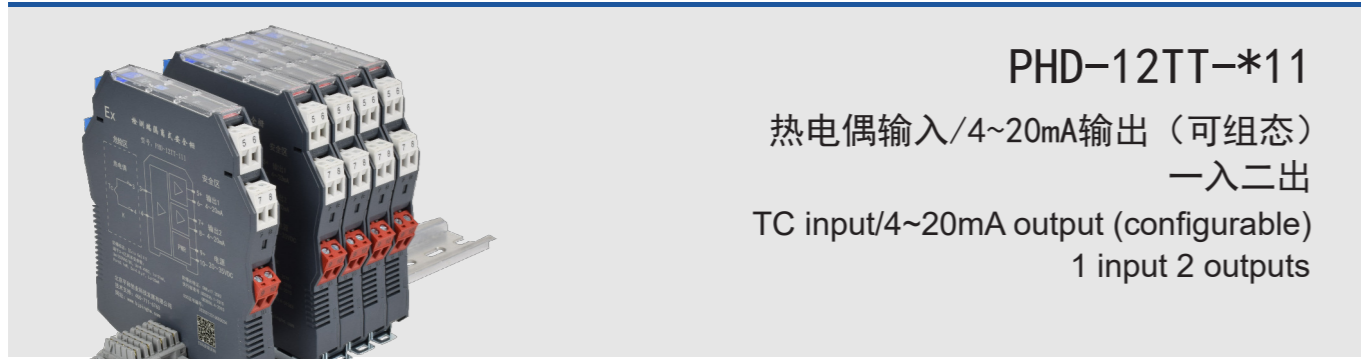

概述 Overview

隔离式检测端安全栅：PHD-12TT-*11，热电偶信号输入，一路输入两路输出。
安全栅可实现将危险区的热电偶信号输入，转换为4~20mA信号输出传送到安全区。电路设一路热电偶信号输入，二路直流4~20mA信号输出。
输出4~20mA信号，可智能组态，实际量程范围可通过计算机进行设定。
PHD-12TT-*11，“*”表示热电偶的输入类型，请用代码表示。本产品需外接20~35VDC电源。

Isolated safety barrier: PHD-12TT-*11, thermocouple signal input, 1 input and 2 outputs, the safety barrier can realize the conversion of thermocouple signal input in dangerous area into 4~20mA signal output and transmit it to safe area. The circuit has one thermocouple input and two DC signal 4~20mA outputs. The output 4~20mA signal can be intelligently configured, and the actual measuring range can be set by computer. PHD-12TT-*11, "*" indicates the input type of thermocouple, please use code to indicate it. This product needs an external power supply of 20~35VDC.

输入信号类型和量程表

代码 Code	热电偶型号 RTD model	测量范围 Measurement range	最小量程 Minimum range	转换精度 Conversion accuracy
1	K	-200 ~ 1370°C	50°C	0.5°C/0.1%
2	S	-50 ~ 1760°C	500°C	1.5°C/0.1%
3	E	-140 ~ 1000°C	50°C	0.5°C/0.1%
4	J	-160 ~ 1200°C	50°C	0.5°C/0.1%
5	B	250 ~ 1800°C	500°C	1.5°C/0.1%
6	T	-200 ~ 400°C	50°C	0.5°C/0.1%
7	R	-50 ~ 1760°C	500°C	1.5°C/0.1%
8	N	-200 ~ 1300°C	50°C	0.5°C/0.1%

例：检测端安全栅K偶输入，温度范围0~1200°C，输出二路4~20mA信号，电源20~35VDC。型号为PHD-12TT-111(0~1200°C)，量程范围可通过计算机设定为指定的0~1200°C范围。
*总线端子供电，详见附录。

Example: when the input is with K-couple, temperature range is 0~1200°C, 2 outputs are 4~20mA, power supply 20~35VDC, then the model should be PHD-12TT-111 (0~1200°C). The measuring range can be set to the specified 0~1200°C range by computer. * Bus terminal power supply, please see appendix for details.

接线图 Wiring diagram

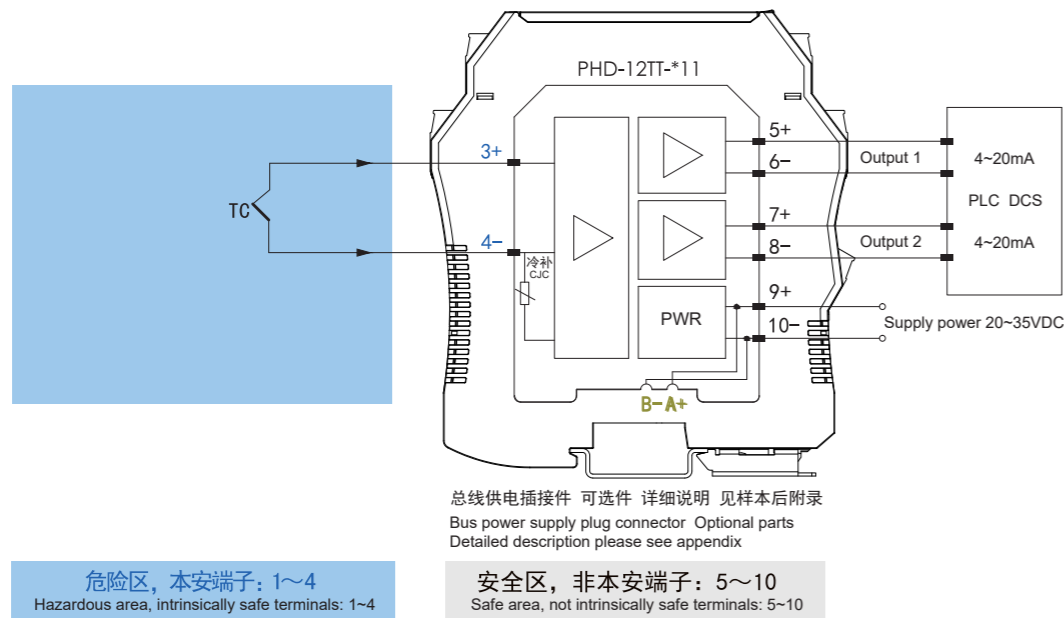

技术数据 Specifications

供电电压 Supply voltage	20~35VDC, 功耗<1.8W (24VDC供电, 20mA输出时) 20~35VDC, power consumption<1.8W (when power supply 24VDC, output 20mA)
输入信号 Input signal	K, S, E, J, B, T, R, N热电偶信号 K, S, E, J, B, T, R, N, TC Signals
输出信号 Output signal	4~20mA
信号范围及量程范围 Signal and measurement range	信号范围: 对应热电偶的测量范围-10~100mV Signal range: corresponding to the measuring range of TC -10~100mV 量程范围: 用户订货时自行制定组态, 在尾号指明或另说明 Measurement range: When make an order, the user shall make the configuration by himself, which shall be indicated in the tail number or extra explained.
允许输出负载能力 Allowable output load capacity	0~500Ω (可定制) 0~500Ω (customizable)
报警指示 Alarm indication	低量程报警L1灯亮; 高量程报警L2灯亮 L1 light is on at low-measurement range alarm; L2 light is on at high-measurement range alarm
输入输出路数 Channel number of input and output	一路输入, 两路输出 1 input 2 outputs
适用的现场设备 Applicable field devices	K, S, E, J, B, T, R, N热电偶传感器 K, S, E, J, B, T, R, N, TC sensors
输出精度 Output accuracy	见上页“输入信号类型和量程表” Please see the "Input signal types and measurement table" in above page
冷端补偿 Cold junction compensation	±1°C (补偿范围-20°C~+60°C) ±1°C (Compensation range -20°C~+60°C)
温度漂移 Temperature drift	0.005%F. S/°C
温度参数 Temperature parameters	工作温度: -20°C~+60°C, 存储温度: -40°C~+80°C Working temperature: -20°C~+60°C, storage temperature: -40°C~+80°C
空气相对湿度 Relative humidity	10%~95%RH无凝露 10%~95%RH no condensation
绝缘强度 Dielectric strength	本安端与非本安端 (≥3000VAC/min); 电源与非本安端之间 (≥1500VAC/min) Between intrinsically safe side and non-intrinsically safe side (≥ 3000VAC/min); between power supply and non-intrinsically safe terminal (≥ 1500VAC/min)
绝缘电阻 Insulation resistance	≥100MΩ (输入/输出/电源间) ≥100MΩ (between input/output/power supply)
电磁兼容性 Electromagnetic compatibility	符合IEC 61326-1 (GB/T 18268), IEC 61326-3-1 According to IEC 61326-1 (GB/T 18268), IEC 61326-3-1
防爆标志 Explosion-proof mark	[Exia Ga]IIC
功能安全认证 Functional safety certification	SIL2 符合IEC 61508 EN 61511标准 SIL2 according to IEC 61508 EN 61511 standards
认证机构 Certification Body	国家防爆电气产品质量监督检验中心CQST认证 CQST (China National Quality Supervision and Test Centre for Explosion Protected Electrical Products)
认证参数 (端子3-4之间) Certified parameters (between terminals 3-4)	Um=250V Uo=8.4V Io=31mA Co=4.8μF Lo=20mH Po=65mW
安装场所要求 Installation place requirements	可与具有IIA、IIB、IIC危险气体的0区本安仪表相连接 It can be connected with instruments in 0 zone with IIA, IIB, IIC dangerous gas
平均无故障时间 MTBF	≤100000小时 (h)

端子定义及外形尺寸 Terminal assignments and dimensions

端子 Terminal	接线端子功能定义 Terminal assignments	范围
9	供电电源+ Power supply +	20~35VDC
10	供电电源- Power supply -	
3	输入+ Input+	TC
4	输入- Input-	
5	输出1+ Output 1+	4~20mA
6	输出1- Output 1-	
7	输出2+ Output 2+	4~20mA
8	输出2- Output 2-	

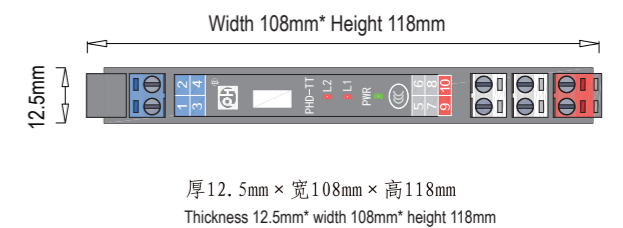

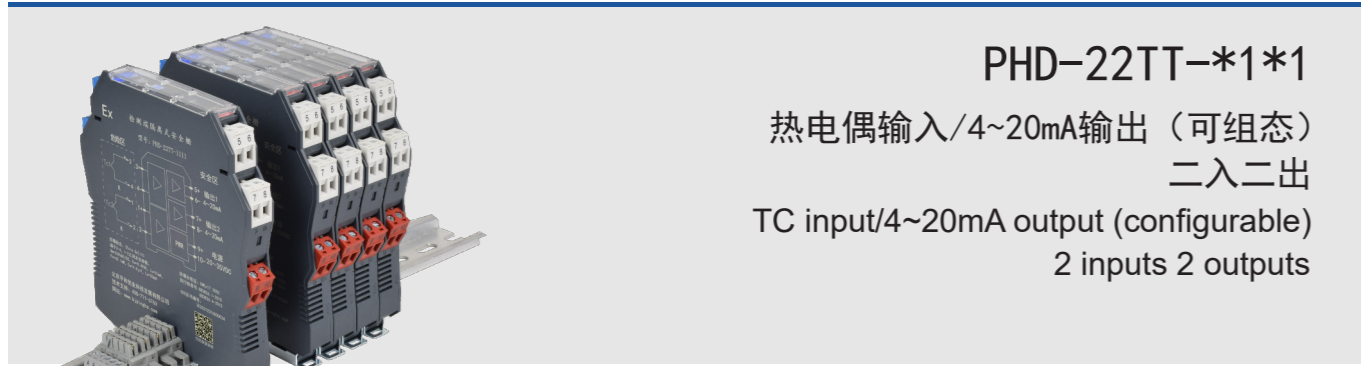

PHD-22TT-*1*1

热电偶输入/4~20mA输出 (可组态)
二入二出
TC input/4~20mA output (configurable)
2 inputs 2 outputs

概述 Overview

隔离式检测端安全栅：PHD-22TT-*1*1，热电偶信号输入，二路输入二路输出。
安全栅可实现将危险区的热电偶信号输入，转换为4~20mA信号输出传送到安全区。电路设二路热电偶信号输入，二路直流4~20mA信号输出。
输出4~20mA信号，可智能组态，实际量程范围可通过计算机进行设定。
PHD-22TT-*1*1，“*”表示热电偶的输入类型，请用代码表示。本产品需外接20~35VDC电源。

Isolated safety barrier: PHD-22TT-*1*1, thermocouple signal input, 2 inputs and 2 outputs, the safety barrier can realize the conversion of thermocouple signal input in dangerous area into 4~20mA signal output and transmit it to safe area.
The circuit has dual thermocouple inputs and dual DC signal 4~20mA outputs. The output 4~20mA signal can be intelligently configured, and the actual measuring range can be set by computer.
PHD-22TT-*1*1, "*" indicates the input type of thermocouple, please use code to indicate it.

This product needs an external power supply of 20~35VDC

输入信号类型和量程表 Input signal types and measurement range				
代码 Code	热电偶型号 RTD model	测量范围 Measurement range	最小量程 Minimum range	转换精度 Conversion accuracy
1	K	-200 ~ 1370 °C	50 °C	0.5 °C / 0.1 %
2	S	-50 ~ 1760 °C	500 °C	1.5 °C / 0.1 %
3	E	-140 ~ 1000 °C	50 °C	0.5 °C / 0.1 %
4	J	-160 ~ 1200 °C	50 °C	0.5 °C / 0.1 %
5	B	250 ~ 1800 °C	500 °C	1.5 °C / 0.1 %
6	T	-200 ~ 400 °C	50 °C	0.5 °C / 0.1 %
7	R	-50 ~ 1760 °C	500 °C	1.5 °C / 0.1 %
8	N	-200 ~ 1300 °C	50 °C	0.5 °C / 0.1 %

Example: when the input are 2 inputs with K-couple, temperature range is 0~1200 °C, 2 outputs 4~20mA, power supply 20~35VDC, then the model should be PHD-22TT-1111 (0~1200 °C).
The measuring range can be set to the specified 0~1200 °C range by computer.
* Bus terminal power supply, please see appendix for details.

例：检测端安全栅二路K偶输入，温度范围0~1200°C，输出二路4~20mA信号，电源20~35VDC。型号为PHD-22TT-1111(0~1200°C)，量程范围可通过计算机设定为指定的0~1200°C范围。
*总线端子供电，详见附录。

接线图 Wiring diagram

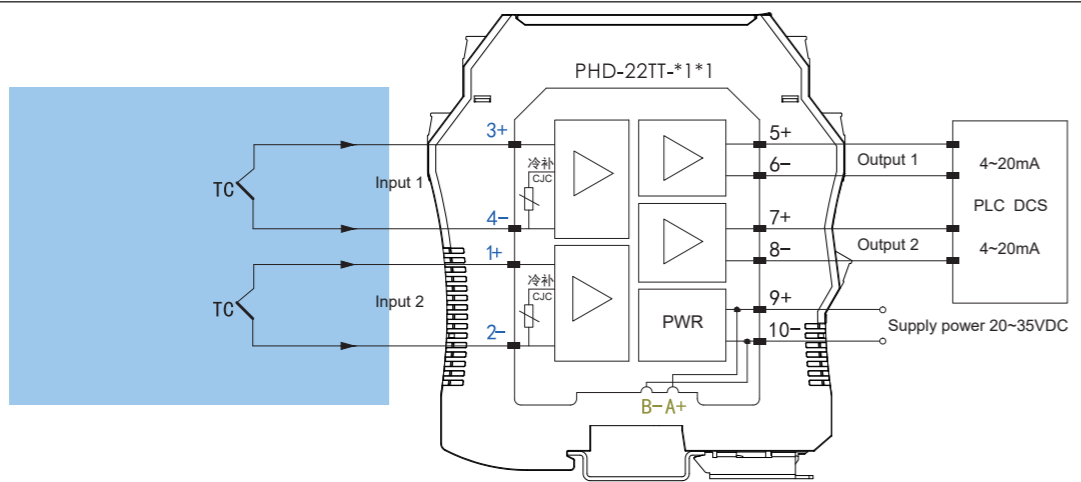

总线供电插接件 可选件 详细说明 见样本后附录
Bus power supply plug connector Optional parts Detailed description please see appendix

危险区，本安端子：1~4
Hazardous area, intrinsically safe terminals: 1~4

安全区，非本安端子：5~10
Safe area, not intrinsically safe terminals: 5~10

技术数据 Specifications

供电电压 Supply voltage	20~35VDC, 功耗<2W (24VDC供电, 20mA输出时) 20~35VDC, power consumption<2W (when power supply 24VDC, output 20mA)
输入信号 Input signal	K, S, E, J, B, T, R, N热电偶信号 K, S, E, J, B, T, R, N, TC Signals
输出信号 Output signal	4~20mA
信号范围及量程范围 Signal and measurement range	信号范围：对应热电偶的测量范围-10~100mV Signal range: corresponding to the measuring range of TC -10~100mV 量程范围：用户订货时自行制定组态，在尾号指明或另说明 Measurement range: When make an order, the user shall make the configuration by himself, which shall be indicated in the tail number or extra explained.
允许输出负载能力 Allowable output load capacity	0~500Ω (可定制) 0~500Ω (customizable)
报警指示 Alarm indication	低量程黄灯亮；高量程红灯亮 The yellow light will be on at low-measurement range; red light will be on at high-measurement range
输入输出路数 Channel number of input and output	二路输入，二路输出 2 inputs 2 outputs
适用的现场设备 Applicable field devices	K, S, E, J, B, T, R, N热电偶传感器 K, S, E, J, B, T, R, N, TC sensors
输出精度 Output accuracy	见上页“输入信号类型和量程表” Please see the "Input signal types and measurement table" in above page
冷端补偿 Cold junction compensation	±1°C (补偿范围-20°C~+60°C) ±1°C (Compensation range -20°C~+60°C)
温度漂移 Temperature drift	0.005%F.S/°C
温度参数 Temperature parameters	工作温度：-20°C~+60°C，存储温度：-40°C~+80°C Working temperature: -20°C~+60°C, storage temperature: -40°C~+80°C
空气相对湿度 Relative humidity	10%~95%RH无凝露 10%~95%RH no condensation
绝缘强度 Dielectric strength	本安端与非本安端 (≥3000VAC/min)；电源与非本安端之间 (≥1500VAC/min) Between intrinsically safe side and non-intrinsically safe side (≥ 3000VAC/min); between power supply and non-intrinsically safe terminal (≥ 1500VAC/min)
绝缘电阻 Insulation resistance	≥100MΩ (输入/输出/电源间) ≥100MΩ (between input/output/power supply)
电磁兼容性 Electromagnetic compatibility	符合IEC 61326-1 (GB/T 18268)，IEC 61326-3-1 According to IEC 61326-1 (GB/T 18268), IEC 61326-3-1
防爆标志 Explosion-proof mark	[Exia Ga]IIC
认证机构 Certification Body	国家防爆电气产品质量监督检验中心CQST认证 CQST (China National Quality Supervision and Test Centre for Explosion Protected Electrical Products)
认证参数 (端子3-4, 1-2之间) Certified parameters (between terminals 3-4, 1-2)	Um=250V Uo=8.4V Io=31mA Co=4.8μF Lo=20mH Po=65mW
安装场所要求 Installation place requirements	可与具有IIA、IIB、IIC危险气体的0区本安仪表相连接 It can be connected with instruments in 0 zone with IIA, IIB, IIC dangerous gas
平均无故障时间 MTBF	≤100000小时 (h)

端子定义及外形尺寸 Terminal assignments and dimensions

端子 Terminal	接线端子功能定义 Terminal assignments	
9	供电电源+ Power supply +	20~35VDC
10	供电电源- Power supply -	
3	输入1+ Input 1+	TC
4	输入1- Input 1-	
1	输入2+ Input 2+	TC
2	输入2- Input 2-	
5	输出1+ Output 1+	4~20mA
6	输出1- Output 1-	
7	输出2+ Output 2+	4~20mA
8	输出2- Output 2-	

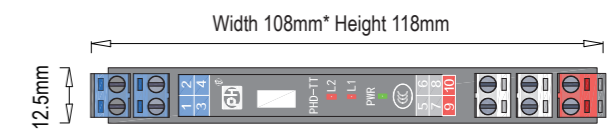

厚12.5mm × 宽108mm × 高118mm
Thickness 12.5mm* width 108mm* height 118mm

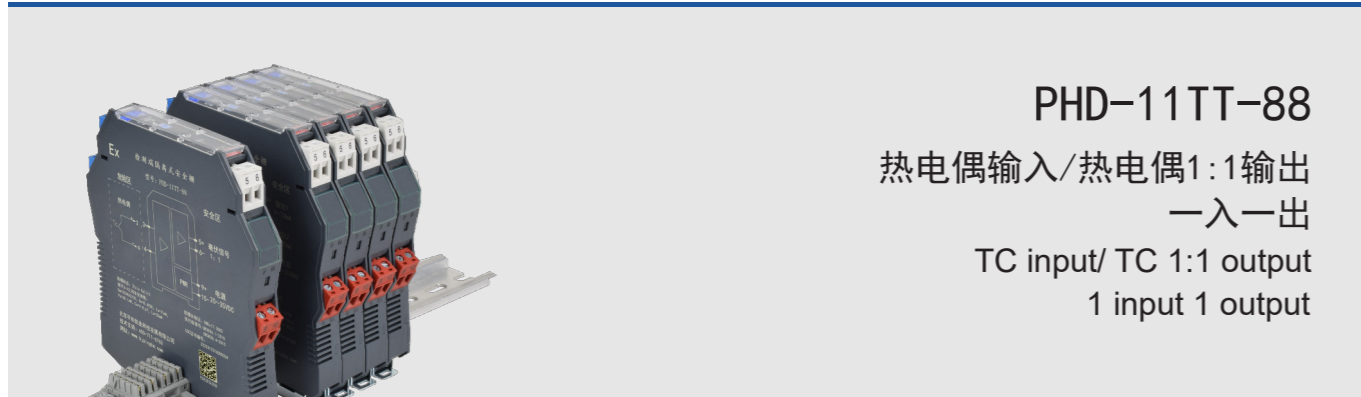

PHD-11TT-88
 热电偶输入/热电偶1:1输出
 一入一出
 TC input/ TC 1:1 output
 1 input 1 output

概述 Overview

隔离式检测端安全栅：PHD-11TT-88，热电偶信号输入，一路输入一路输出。

安全栅可实现将危险区的热电偶信号（-5~60mV）1:1传送到安全区，热电偶可以是K、S、E、J、B、T、R、N类型之一。本产品需要外接20~35VDC电源。

订购时注明具体参数

*总线端子供电，详见附录。

Isolated safety barrier at detection side: PHD-11TT-88, thermocouple signal input, single input and single output.

The isolated safety barrier can realize the transmission of thermocouple signals (-5~60mV) from dangerous areas in proportion 1:1 to the safe area, and thermocouples can be K, S, E, J, B, T, R, N types.

This product needs an external 20~35VDC power supply.

When ordering, please indicate the specific parameters

*Bus terminal power supply, please see appendix for details.

接线图 Wiring diagram

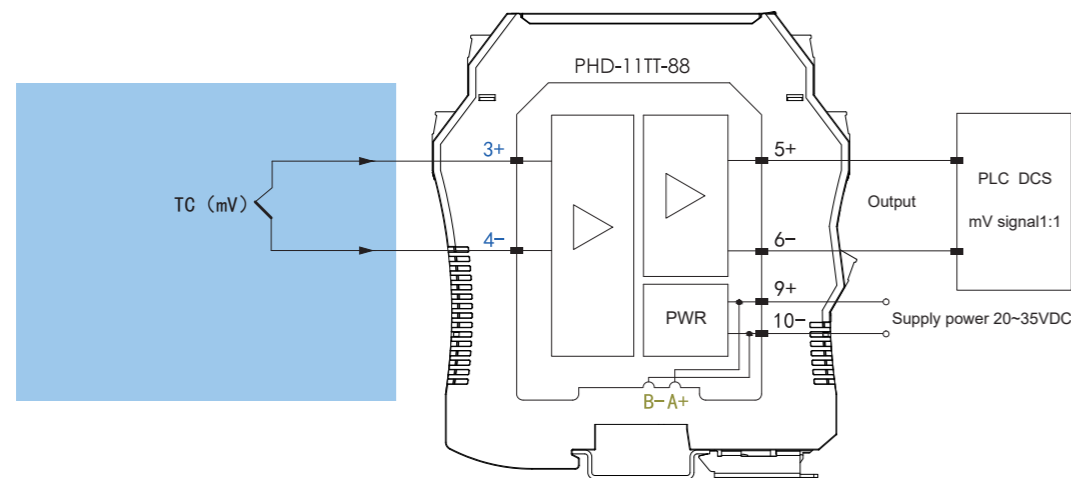

总线供电插接件 可选件 详细说明 见样本后附录
 Bus power supply plug connector Optional parts
 Detailed description please see appendix

危险区，本安端子：1~4
 Hazardous area, intrinsically safe terminals: 1~4

安全区，非本安端子：5~10
 Safe area, not intrinsically safe terminals: 5~10

技术数据 Specifications

供电电压 Supply voltage	20~35VDC, 功耗<0.8W 20~35VDC, power consumption<0.8W
输入信号 Input signal	K、S、E、J、B、T、R、N热电偶信号 K, S, E, J, B, T, R, N, TC Signals
输出信号 Output signal	热电偶1:1 TC 1:1
信号范围 Signal range	对应热电偶的测量范围-5~60mV Corresponding to the measuring range of TC -5~60mV
输入输出路数 Channel number of input and output	一路输入，一路输出 1 input 1 output
适用的现场设备 Applicable field devices	K、S、E、J、B、T、R、N热电偶传感器 K, S, E, J, B, T, R, N, TC sensors
输出精度 Output accuracy	0.1%F.S (典型值: 0.05%F.S) 0.1%F.S (Typical value: 0.05%F.S)
温度漂移 Temperature drift	0.005%F.S/°C
温度参数 Temperature parameters	工作温度: -20°C~+60°C, 存储温度: -40°C~+80°C Working temperature: -20°C~+60°C, storage temperature: -40°C~+80°C
空气相对湿度 Relative humidity	10%~95%RH无凝露 10%~95% RH no condensation
绝缘强度 Dielectric strength	本安端与非本安端 (≥3000VAC/min); 电源与非本安端之间 (≥1500VAC/min)
绝缘电阻 Insulation resistance	≥100MΩ (输入/输出/电源间) ≥100MΩ (between input/output/power supply)
电磁兼容性 Electromagnetic compatibility	符合IEC 61326-1 (GB/T 18268), IEC 61326-3-1 According to IEC 61326-1 (GB/T 18268), IEC 61326-3-1
防爆标志 Explosion-proof mark	[Exia Ga]IIC
认证机构 Certification Body	国家防爆电气产品质量监督检验中心CQST认证 CQST (China National Quality Supervision and Test Centre for Explosion Protected Electrical Products)
认证参数 (端子3-4之间) Certified parameters (between terminals 3-4)	Um=250V Uo=8.4V Io=31mA Co=4.8μF Lo=20mH Po=65mW
安装场所要求 Installation place requirements	可与具有IIA、IIB、IIC危险气体的0区本安仪表相连接 It can be connected with instruments in 0 zone with IIA, IIB, IIC dangerous gas
平均无故障时间 MTBF	≤100000小时 (h)

端子定义及外形尺寸 Terminal assignments and dimensions

端子 Terminal	接线端子功能定义 Terminal assignments
9	供电电源+ Power supply +
10	供电电源- Power supply -
3	输入+ Input+
4	输入- Input-
5	输出+ Output+
6	输出- Output-

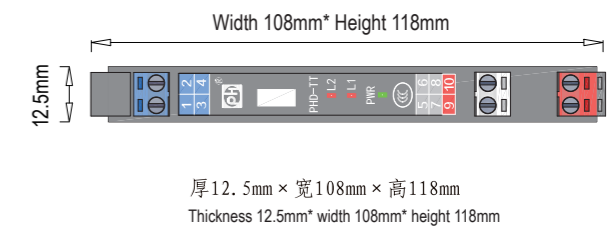

检测端安全栅 Isolated Safety Barrier at Detection Side

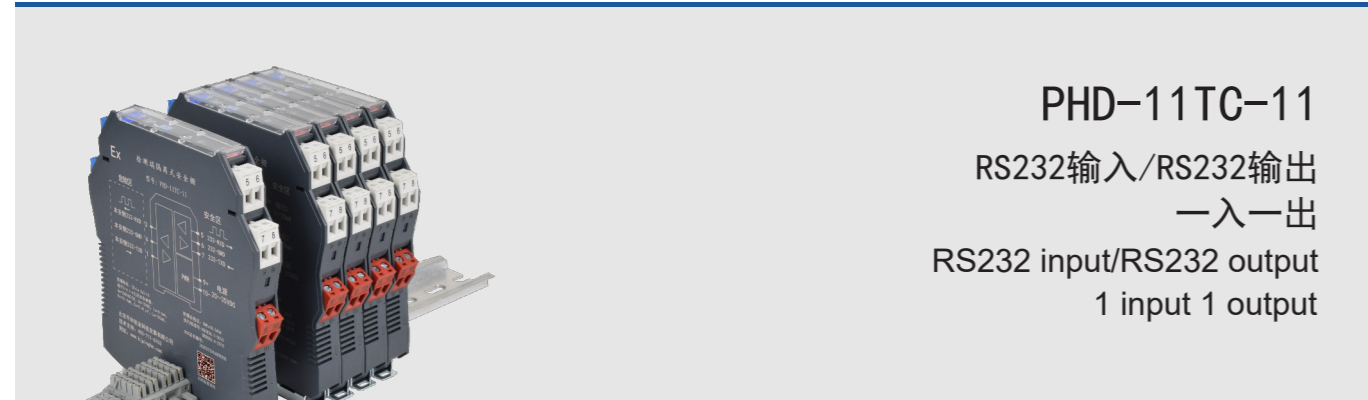

PHD-11TC-11
RS232输入/RS232输出
一入一出
RS232 input/RS232 output
1 input 1 output

概述 Overview

隔离式检测端安全栅：PHD-11TC-11，通讯信号输入，一路输入一路输出。

安全栅可实现：在危险区的RS232接口与在安全区的RS232接口之间，数字信号的双向通讯。
本产品需要外接20~35VDC电源。
产品带信号状态指示灯(黄色)。

*总线端子供电，详见附录。

Isolated safety barrier at detection end: PHD-11TC-11, communication signal input, single input and single output.

The safety barrier can realize the bilateral communication of digital signals between RS232 interface in dangerous area and RS232 interface in safe area.
This product needs an external 20~35VDC power supply.
The product is equipped with signal status indicator (yellow)

* Bus terminal power supply, please see appendix for details.

接线图 Wiring diagram

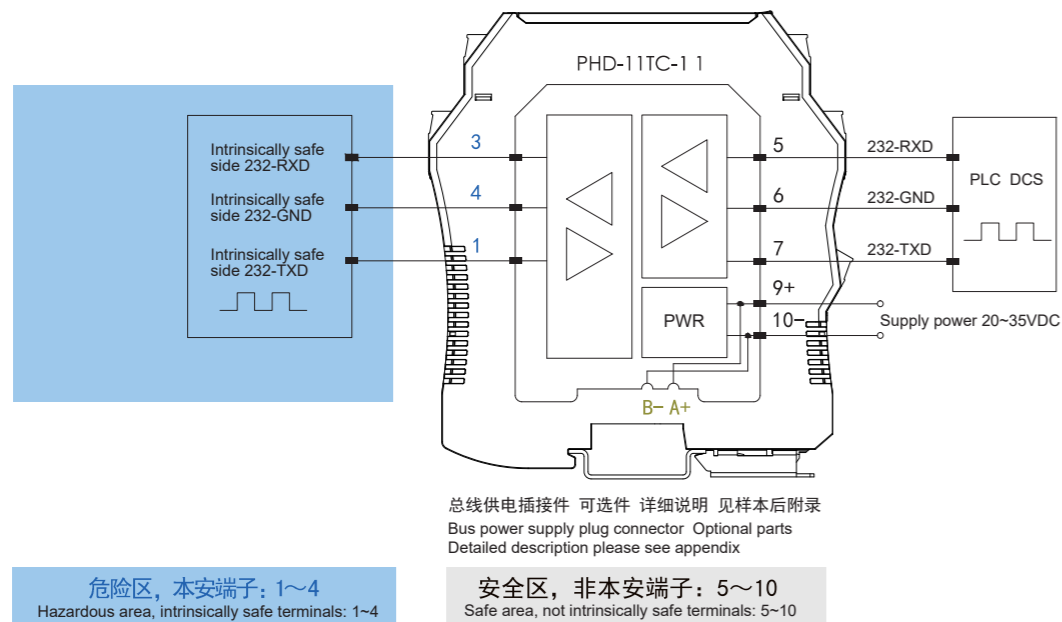

Communication Signal Input 通讯信号输入

技术数据 Specifications

供电电压 Supply voltage	20~35VDC, 功耗<1.5W 20~35VDC, power consumption<1.5W
输入信号 Input signal	RS232数字信号 RS232 digital signal
输出信号 Output signal	RS232数字信号 RS232 digital signal
输入输出路数 Channel number of input and output	一路输入, 一路输出 1 input 1 output
适用的现场设备 Applicable field devices	带RS232的通讯接口设备 Communication interface equipment with RS232
传输速度 Transmission rate	传输速率≤56kbps Transmission rate ≤56kbps
传输延时 Transmission delay	≤10 μs
发送与接收切换时间 Sending and receiving switching time	≥20ms
温度参数 Temperature parameters	工作温度: -20℃~+60℃, 存储温度: -40℃~+80℃ Working temperature: -20℃~+60℃, storage temperature: -40℃~+80℃
空气相对湿度 Relative humidity	10%~95%RH无凝露 10%~95% RH no condensation
绝缘强度 Dielectric strength	本安端与非本安端 (≥3000VAC/min); 电源与非本安端之间 (≥1500VAC/min) Between intrinsically safe side and non-intrinsically safe side (≥ 3000VAC/min); between power supply and non-intrinsically safe terminal (≥ 1500VAC/min)
绝缘电阻 Insulation resistance	≥100MΩ (输入/输出/电源间) ≥100MΩ (between input/output/power supply)
电磁兼容性 Electromagnetic compatibility	符合IEC 61326-1 (GB/T 18268), IEC 61326-3-1 According to IEC 61326-1 (GB/T 18268), IEC 61326-3-1
防爆标志 Explosion-proof mark	[Exia Ga]IIC
认证机构 Certification Body	国家防爆电气产品质量监督检验中心CQST认证 CQST (China National Quality Supervision and Test Centre for Explosion Protected Electrical Products)
认证参数 (端子1-3-4之间) Authentication parameters (between terminals 1-3-4)	Um=250V Uo=15V Io=8.5mA Co=0.41 μF Lo=100mH Po=31.9mW
安装场所要求 Installation place requirements	可与具有IIA、IIB、IIC危险气体的0区本安仪表相连接 It can be connected with instruments in 0 zone with IIA, IIB, IIC dangerous gas
平均无故障时间 MTBF	≤100000小时 (h)

端子定义及外形尺寸 Terminal assignments and dimensions

端子 Terminal	接线端子功能定义 Terminal assignments
9	供电电源+ Power supply +
10	供电电源- Power supply -
3	本安侧RS232-RXD Intrinsically safe side RS232-RXD
4	本安侧RS232-GND Intrinsically safe side RS232-GND
1	本安侧RS232-TXD Intrinsically safe side RS232-TXD
5	RS232-RXD
6	RS232-GND
7	RS232-TXD

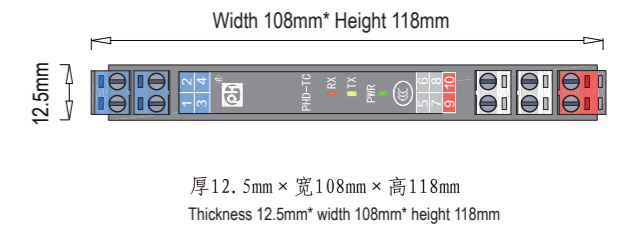

检测端安全栅 Isolated Safety Barrier at Detection Side



PHD-11TC-22
RS485全双工输入/RS485全双工输出
一入一出
RS485 full-duplex input /RS485 full-duplex output
1 input 1 output

概述 Overview

隔离式检测端安全栅：PHD-11TC-22，通讯信号输入，一路输入一路输出。

安全栅可实现：在危险区的RS485接口与在安全区的RS485接口之间，全双工数字信号的双向通讯。

本产品需要外接20~35VDC电源。
产品带信号状态指示灯(黄色)。

*总线端子供电，详见附录。

Isolated safety barrier at detection end: PHD-11TC-22, communication signal input, single input and single output.

The safety barrier can realize the bilateral communication of full duplex digital signals between RS485 interface in dangerous area and RS485 interface in safe area.

This product needs an external 20~35VDC power supply.
The product is equipped with signal status indicator (yellow).

* Bus terminal power supply, please see appendix for details.

接线图 Wiring diagram

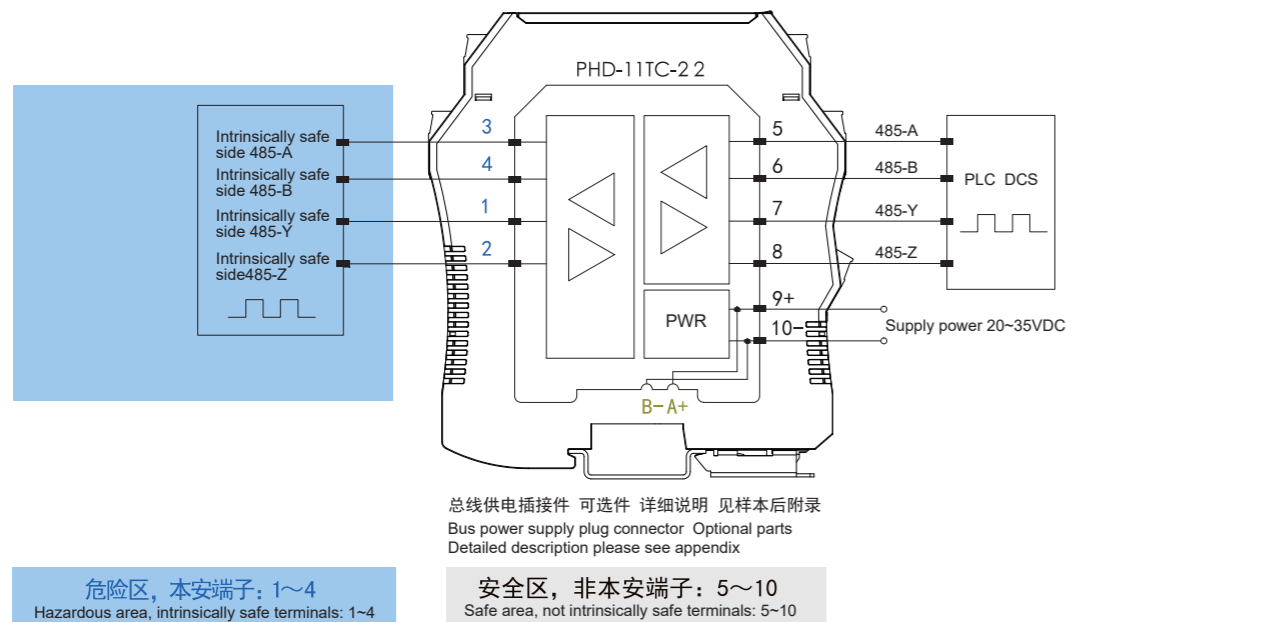

Communication Signal Input 通讯信号输入

技术数据 Specifications

供电电压 Supply voltage	20~35VDC, 功耗约1.5W 20~35VDC, power consumption about 1.5W
输入信号 Input signal	RS485全双工数字信号 RS485 full-duplex digital signal
输出信号 Output signal	RS485全双工数字信号 RS485 full-duplex digital signal
输入输出路数 Channel number of input and output	一路输入, 一路输出 1 input 1 output
适用的现场设备 Applicable field devices	带RS485全双工的通讯接口设备 Equipment with RS485 full-duplex communication interface
传输速度 Transmission rate	传输速率≤115.2kbps Transmission rate ≤115.2kbps
传输延时 Transmission delay	≤10 μs
发送与接收切换时间 Sending and receiving switching time	≥20ms
温度参数 Temperature parameters	工作温度: -20℃~+60℃, 存储温度: -40℃~+80℃ Working temperature: -20 C ~+60 C, storage temperature: -40 C ~+80 C
空气相对湿度 Relative humidity	10%~95%RH无凝露 10%~95% RH no condensation
绝缘强度 Dielectric strength	本安端与非本安端 (≥3000VAC/min); 电源与非本安端之间 (≥1500VAC/min)
绝缘电阻 Insulation resistance	≥100MΩ (输入/输出/电源间) ≥100MΩ (between input/output/power supply)
电磁兼容性 Electromagnetic compatibility	符合IEC 61326-1 (GB/T 18268), IEC 61326-3-1 According to IEC 61326-1 (GB/T 18268), IEC 61326-3-1
防爆标志 Explosion-proof mark	[Exia Ga]IIC
认证机构 Certification Body	国家防爆电气产品质量监督检验中心CQST认证 CQST (China National Quality Supervision and Test Centre for Explosion Protected Electrical Products)
认证参数 (端子1-2-3-4之间) Authentication parameters (between terminals 1-2-3-4)	Um=250V Uo=7.7V Io=80mA Co=6.9 μF Lo=5mH Po=0.15mW
安装场所要求 Installation place requirements	可与具有IIA、IIB、IIC危险气体的0区本安仪表相连接 It can be connected with instruments in 0 zone with IIA, IIB, IIC dangerous gas
平均无故障时间 MTBF	约100000小时 About 100000h

端子定义及外形尺寸 Terminal assignments and dimensions

端子 Terminal	接线端子功能定义 Terminal assignments
9	供电电源+ Power supply +
10	供电电源- Power supply -
3	本安侧RS485-A Intrinsically safe side RS485-A
4	本安侧RS485-B Intrinsically safe side RS232-B
1	本安侧RS485-Y Intrinsically safe side RS232-Y
2	本安侧RS485-Z Intrinsically safe side RS232-Z
5	RS485-A
6	RS485-B
7	RS485-Y
8	RS485-Z

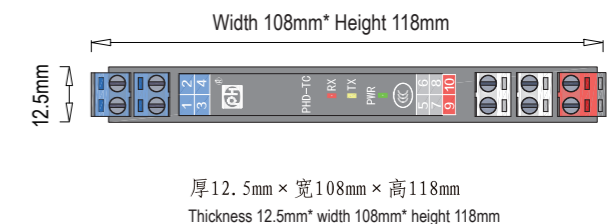

检测端安全栅 Isolated Safety Barrier at Detection Side



PHD-11TC-33*
RS485半双工输入/RS485半双工输出
一入一出
RS485 half-duplex input /RS485 half-duplex output
1 input 1 output

概述 Overview

隔离式检测端安全栅：PHD-11TC-33*，通讯信号输入，一路输入一路输出。
安全栅可实现：在危险区的RS485接口与在安全区的RS485接口之间，半双工数字信号的双向通讯。
电路为现场仪表提供配电电源。
本产品需要外接20~35VDC电源。
产品带信号状态指示灯(黄色)。
型号字母中：PHD-11TC-33*的“*”表示配电电压，规定如下：

代码 Code	配电电压，电流 Provided voltage, current
无 No	无配电 No provided power
A	5V
B	6V
C	12V
F	24V
H	用户自定义 User defined

*总线端子供电，详见附件。

Isolated safety barrier at detection end: PHD-11TC-33*, communication signal input, single input and single output. The safety barrier can realize the bilateral communication of half duplex digital signals between RS485 interface in dangerous area and RS485 interface in safe area.
The circuit provides for field instruments power supply.
This product needs an external 20~35VDC power supply.
The product is equipped with signal status indicator (yellow)
In model letter: PHD-11C-33* the character "*" represents the provided voltage, and the regulations are as follows:

* Bus terminal power supply, please see appendix for details.

接线图 Wiring diagram

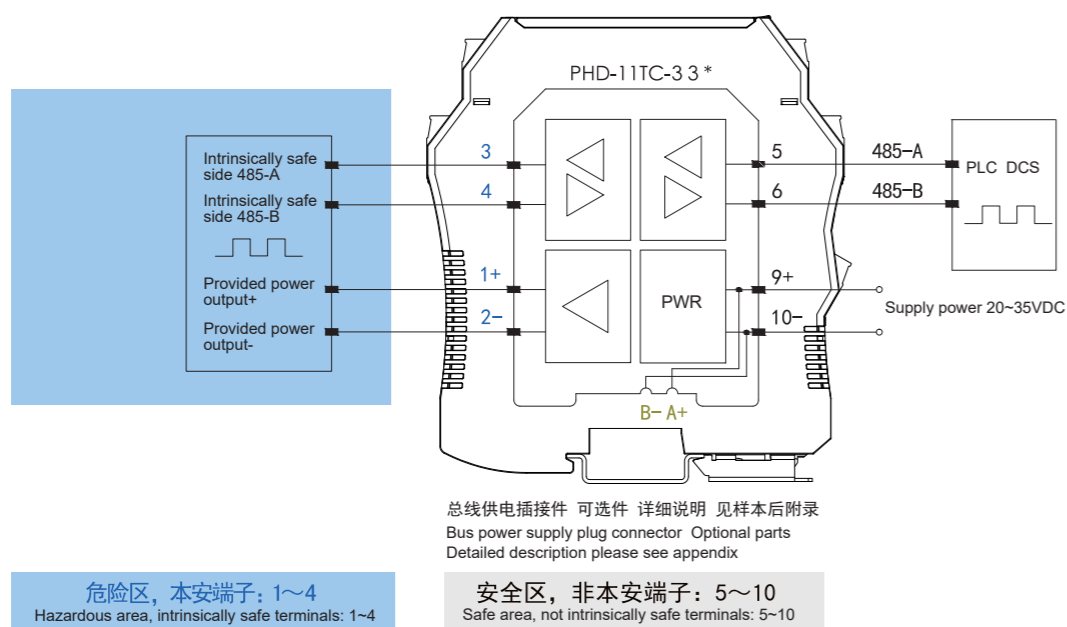

Communication Signal Input 通讯信号输入

技术数据 Specifications

供电电压 Supply voltage	20~35VDC, 功耗<2.5W (24VDC, 配电5V带载80mA时) 20~35VDC, power consumption <2.5W (24VDC, when provided power supply is 5V with 80mA load)
输入信号 Input signal	RS485半双工数字信号 RS485 half-duplex digital signal
配电电压 Provided voltage	为现场仪表提供配电电源: 5V、6V、12V、24V For field instruments provides supply power: 5V, 6V, 12V, 24V
输出信号 Output signal	RS485半双工数字信号 RS485 half-duplex digital signal
输入输出路数 Channel number of input and output	一路输入，一路输出 1 input 1 output
适用的现场设备 Applicable field devices	带RS485半双工的通讯接口设备 Equipment with RS485 half-duplex communication interface
传输速度 Transmission rate	传输速率≤115.2kbps Transmission rate ≤115.2kbps
传输延时 Transmission delay	≤10 μs
发送与接收切换时间 Sending and receiving switching time	≥20ms
温度参数 Temperature parameters	工作温度: -20℃~+60℃, 存储温度: -40℃~+80℃ Working temperature: -20℃~+60℃, storage temperature: -40℃~+80℃
空气相对湿度 Relative humidity	10%~95%RH无凝露 10%~95%RH no condensation
绝缘强度 Dielectric strength	本安端与非本安端 (≥3000VAC/min); 电源与非本安端之间 (≥1500VAC/min) Between intrinsically safe side and non-intrinsically safe side (≥3000VAC/min); between power supply and non-intrinsically safe terminal (≥1500VAC/min)
绝缘电阻 Insulation resistance	≥100MΩ (输入/输出/电源间) ≥100MΩ (between input/output/power supply)
电磁兼容性 Electromagnetic compatibility	符合IEC 61326-1 (GB/T 18268), IEC 61326-3-1 According to IEC 61326-1 (GB/T 18268), IEC 61326-3-1
防爆标志 Explosion-proof mark	[Exia Ga]IIC
认证机构 Certification Body	国家防爆电气产品质量监督检验中心CQST认证 CQST (China National Quality Supervision and Test Centre for Explosion Protected Electrical Products)
认证参数(端子1-2之间) Authentication parameters (between terminals 1-2)	Um=250V Uo=17.85V Io=250mA Co=0.22 μF Lo=0.25mH Po=1.12mW
认证参数(端子3-4之间) Authentication parameters (between terminals 3-4)	Um=250V Uo=7.7V Io=80mA Co=6.9 μF Lo=5.0mH Po=0.15mW
安装场所要求 Installation place requirements	可与具有IIA、IIB、IIC危险气体的0区本安仪表相连接 It can be connected with instruments in 0 zone with IIA, IIB, IIC dangerous gas
平均无故障时间 MTBF	≤100000小时 (h)

端子定义及外形尺寸 Terminal assignments and dimensions

端子 Terminal	接线端子功能定义 Terminal assignments
9	供电电源+ Power supply +
10	供电电源- Power supply -
3	本安侧RS485-A Intrinsically safe side RS485-A
4	本安侧RS485-B Intrinsically safe side RS485-B
1	配电电源+ Provided power supply+
2	配电电源- Provided power supply-
6	RS485-A
7	RS485-B

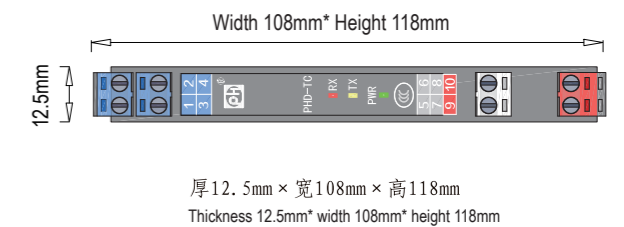

检测端安全栅 Isolated Safety Barrier at Detection Side

Frequency Input 频率量输入

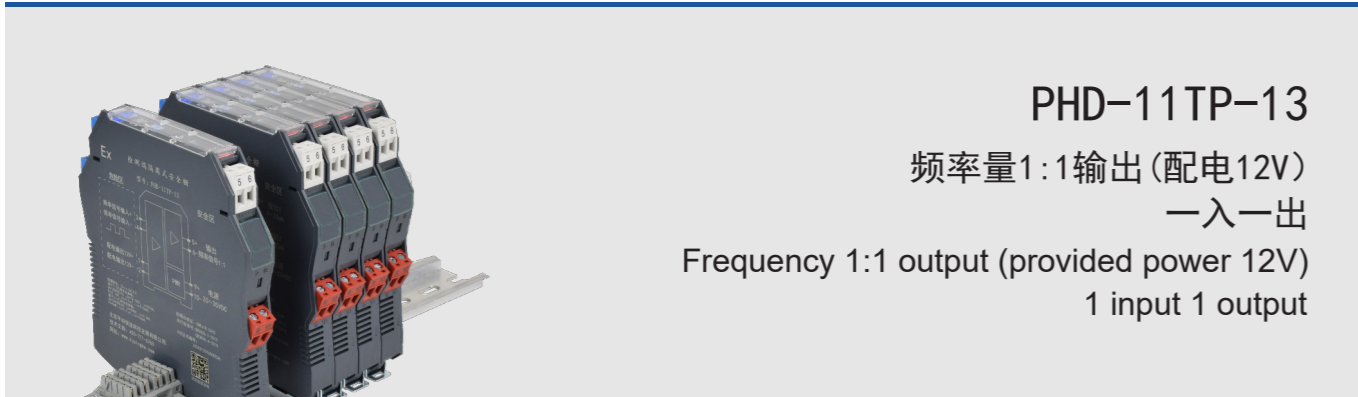

PHD-11TP-13

频率量1:1输出(配电12V)

一入一出

Frequency 1:1 output (provided power 12V)

1 input 1 output

概述 Overview

隔离式检测端安全栅：PHD-11TP-13，频率量输入，一路输入一路输出。

安全栅可实现将危险区的频率信号传输到安全区，频率量1:1输出，具有较强的抗干扰能力。电路为现场仪表提供12VDC配电电压。本产品需要外接20~35VDC电源。

*总线端子供电，详见附录。

Isolated safety barrier at detection end: PHD-11TP-13, frequency input, single input and single output.

The safety barrier can transmit the frequency signal in dangerous area to safe area with in frequency output in proportion 1:1, has very strong an-interference ability.

The circuit provides for the field instrument 12 VDC provided power supply.

This product needs an external 20~35VDC power supply.

* Bus terminal power supply, please see appendix for details.

接线图 Wiring diagram

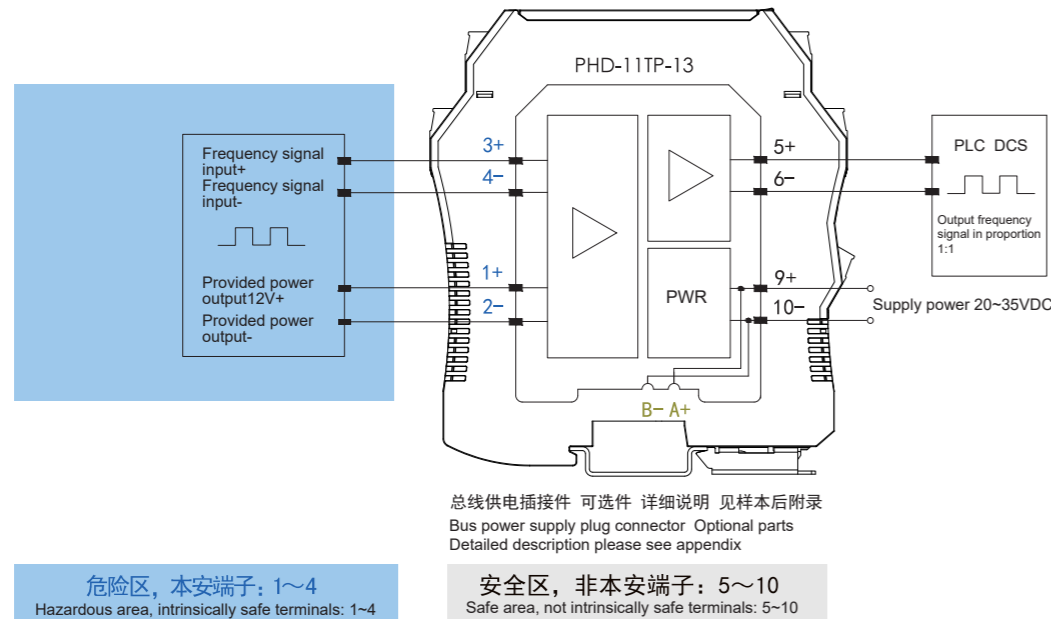

技术数据 Specifications

供电电压 Supply voltage	20~35VDC, 功耗约2.0W 20~35VDC, power consumption about 2.0W
配电电压 Provided voltage	开路电压≤13V, 带载25mA时配电电压≥8.5V Open circuit voltage≤13V, provided voltage≥8.5V when with load 25mA
输入信号 Input signal	频率≤100KHz, 幅值≤12V, 占空比≥20%, 高电平≥4V, 低电平≤1V Frequency ≤100KHz, amplitude ≤12V, duty cycle ≥20%, high level ≥4V, low level ≤1V
输出信号 Output signal	频率量1:1输出, 高电平≥10V, 低电平≤0.5V, 驱动电流≤15mA, 负载电阻≥1KΩ Frequency 1:1 output, high level ≥10V, low level ≤0.5V, driving current ≤15mA, load resistance ≥1KΩ
输入输出路数 Channel number of input and output	一路输入, 一路输出 1 input 1 output
适用的现场设备 Applicable field devices	频率量设备 Frequency equipment
温度参数 Temperature parameters	工作温度: -20℃~+60℃, 存储温度: -40℃~+80℃ Working temperature: -20℃~+60℃, storage temperature: -40℃~+80℃
空气相对湿度 Relative humidity	10%~95%RH无凝露 10%~95% RH no condensation
绝缘强度 Dielectric strength	本安端与非本安端 (≥3000VAC/min); 电源与非本安端之间 (≥1500VAC/min) Between intrinsically safe side and non-intrinsically safe side (≥3000VAC/min); between power supply and non-intrinsically safe terminal (≥1500VAC/min)
绝缘电阻 Insulation resistance	≥100MΩ (输入/输出/电源间) ≥100MΩ (between input/output/power supply)
电磁兼容性 Electromagnetic compatibility	符合IEC 61326-1 (GB/T 18268), IEC 61326-3-1 According to IEC 61326-1 (GB/T 18268), IEC 61326-3-1
防爆标志 Explosion-proof mark	[Exia Ga] IIC
认证机构 Certification Body	国家防爆电气产品质量监督检验中心CQST认证 CQST (China National Quality Supervision and Test Centre for Explosion Protected Electrical Products)
认证参数(端子1-2之间) Authentication parameters (between terminals 1-2)	Um=250V Uo=14.7V Io=207mA Co=0.5μF Lo=0.35mH Po=0.76mW
认证参数(端子3-4之间) Authentication parameters (between terminals 3-4)	Um=250V Uo=8V Io=2.5mA Co=3.5μF Lo=100mH Po=5mW
安装场所要求 Installation place requirements	可与具有IIA、IIB、IIC危险气体的0区本安仪表相连接 It can be connected with instruments in 0 zone with IIA, IIB, IIC dangerous gas
平均无故障时间 MTBF	约100000小时 About 100000h

端子定义及外形尺寸 Terminal assignments and dimensions

端子 Terminal	接线端子功能定义 Terminal assignments	
9	供电电源+ Power supply +	20~35VDC
10	供电电源- Power supply -	
1	配电电源12V+ Provided power supply 12V+	
2	配电电源- Provided power supply-	
3	输入+ Input+	频率量
4	输入- Input-	Frequency
5	输出+ Output+	频率量
6	输出- Output-	Frequency



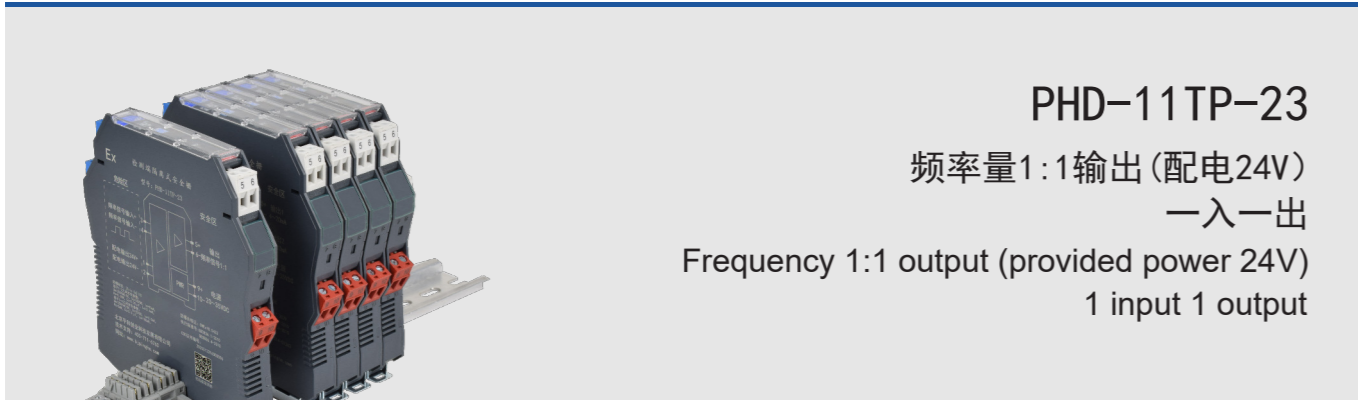

概述 Overview

隔离式检测端安全栅：PHD-11TP-23，频率量输入，一路输入一路输出。

安全栅可实现将危险区的频率信号传输到安全区，频率量1:1输出，具有较强的抗干扰能力。
电路为现场仪表提供24VDC配电电压。
本产品需要外接20~35VDC电源。

*总线端子供电，详见附录。

Isolated safety barrier at detection end: PHD-11TP-23, frequency input, single input and single output.

The safety barrier can transmit the frequency signal in dangerous area to safe area and output with frequency in proportion 1:1, has very strong an-interference ability.

The circuit provides for the field instrument 24 VDC provided power supply. This product needs an external 20~35VDC power supply.

* Bus terminal power supply, please see appendix for details.

接线图 Wiring diagram

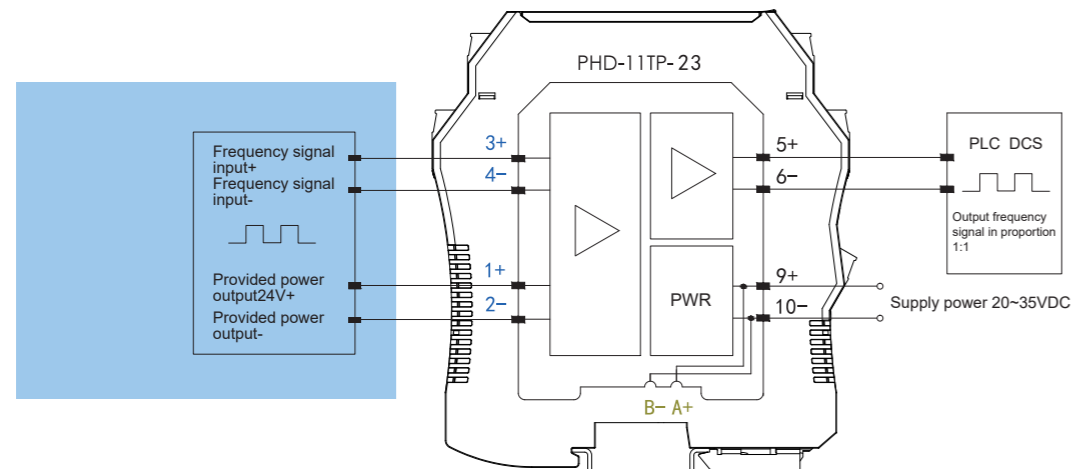

危险区，本安端子：1~4
Hazardous area, intrinsically safe terminals: 1~4

安全区，非本安端子：5~10
Safe area, not intrinsically safe terminals: 5~10

技术数据 Specifications

供电电压 Supply voltage	20~35VDC, 功耗约2.0W 20~35VDC, power consumption about 2.0W
配电电压 Provided voltage	开路电压≤25V, 带载25mA时配电电压≥16V Open circuit voltage≤25V, provided voltage ≥16V when with load 25mA
输入信号 Input signal	频率≤100KHz, 幅值≤24V, 占空比≥20%, 高电平≥4V, 低电平≤1V Frequency ≤100KHz, amplitude ≤24V, duty cycle ≥20%, high level ≥4V, low level ≤1V
输出信号 Output signal	频率量1:1输出, 高电平≥20V, 低电平≤0.5V, 驱动电流≤15mA, 负载电阻≥1KΩ Frequency 1:1 output, high level ≥20V, low level ≤0.5V, driving current ≤15mA, load resistance ≥1KΩ
输入输出路数 Channel number of input and output	一路输入, 一路输出 1 input 1 output
适用的现场设备 Applicable field devices	频率量设备 Frequency equipment
温度参数 Temperature parameters	工作温度: -20℃~+60℃, 存储温度: -40℃~+80℃ Working temperature: -20℃~+60℃, storage temperature: -40℃~+80℃
空气相对湿度 Relative humidity	10%~95%RH无凝露 10%~95% RH no condensation
绝缘强度 Dielectric strength	本安端与非本安端 (≥3000VAC/min); 电源与非本安端之间 (≥1500VAC/min) Between intrinsically safe side and non-intrinsically safe side (≥3000VAC/min); between power supply and non-intrinsically safe terminal (≥1500VAC/min)
绝缘电阻 Insulation resistance	≥100MΩ (输入/输出/电源间) ≥100MΩ (between input/output/power supply)
电磁兼容性 Electromagnetic compatibility	符合IEC 61326-1 (GB/T 18268), IEC 61326-3-1 According to IEC 61326-1 (GB/T 18268), IEC 61326-3-1
防爆标志 Explosion-proof mark	[Exia Ga] IIC
认证机构 Certification Body	国家防爆电气产品质量监督检验中心CQST认证 CQST (China National Quality Supervision and Test Centre for Explosion Protected Electrical Products)
认证参数(端子1-2之间) Authentication parameters (between terminals 1-2)	Um=250V Uo=28V Io=93mA Co=0.05 μF Lo=2.4mH Po=0.65mW
认证参数(端子3-4之间) Authentication parameters (between terminals 3-4)	Um=250V Uo=8V Io=2.5mA Co=3.5 μF Lo=100mH Po=5mW
安装场所要求 Installation place requirements	可与具有IIA、IIB、IIC危险气体的0区本安仪表相连接 It can be connected with instruments in 0 zone with IIA, IIB, IIC dangerous gas
平均无故障时间 MTBF	约100000小时 About 100000h

端子定义及外形尺寸 Terminal assignments and dimensions

端子 Terminal	接线端子功能定义 Terminal assignments	
9	供电电源+ Power supply +	20~35VDC
10	供电电源- Power supply -	
1	配电电源24V+ Provided power supply 24V+	
2	配电电源- Provided power supply-	
3	输入+ Input+	频率量
4	输入- Input-	Frequency
5	输出+ Output+	频率量
6	输出- Output-	Frequency

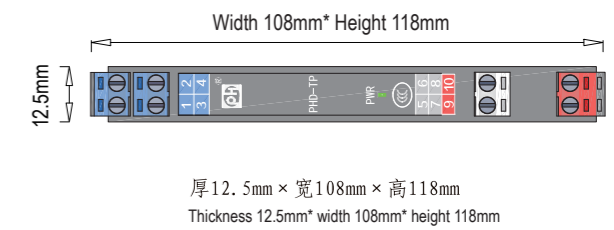

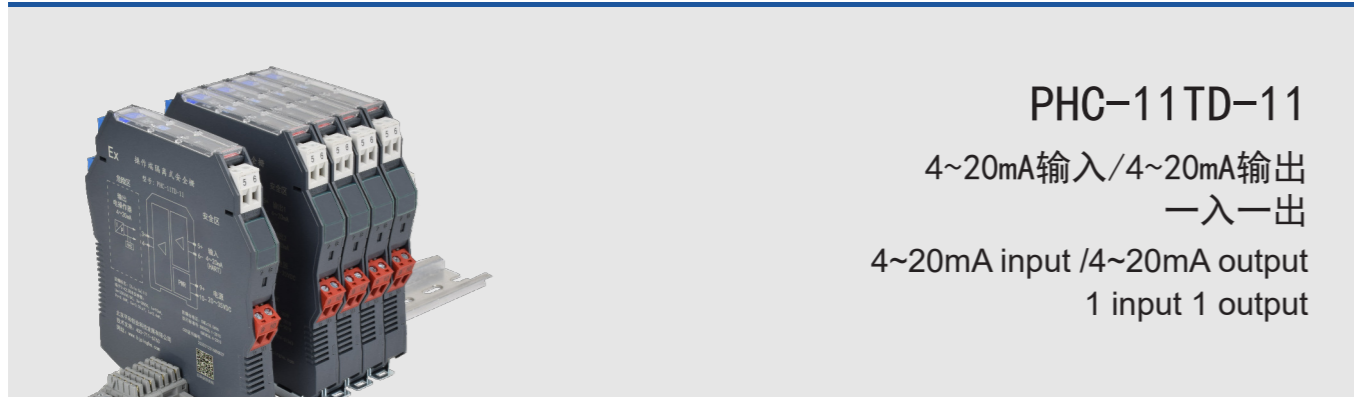

PHC-11TD-11

4~20mA输入/4~20mA输出
一入一出
4~20mA input /4~20mA output
1 input 1 output

概述 Overview

隔离式操作端安全栅PHC-11TD-11，模拟量输入输出，一路输入一路输出。

安全栅可将安全区4~20mA信号传输到危险区，驱动现场的阀门定位器、电/气转换器等执行机构工作。

本产品需要外接20~35VDC电源。

电源、输入、输出三端隔离。

*总线端子供电，详见附录。

Isolated safety barrier at operating side: PHC-11TD-11, input and output with analog signal, single input and single output.

The safety barrier can transmit the 4~20mA signal from safe area to the dangerous area, to drive the valve positioner, electric/gas converters and other actuators to work.

This product needs an external 20~35VDC power supply.

Terminal isolation between power supply, input and output.

* Bus terminal power supply, please see appendix for details.

接线图 Wiring diagram

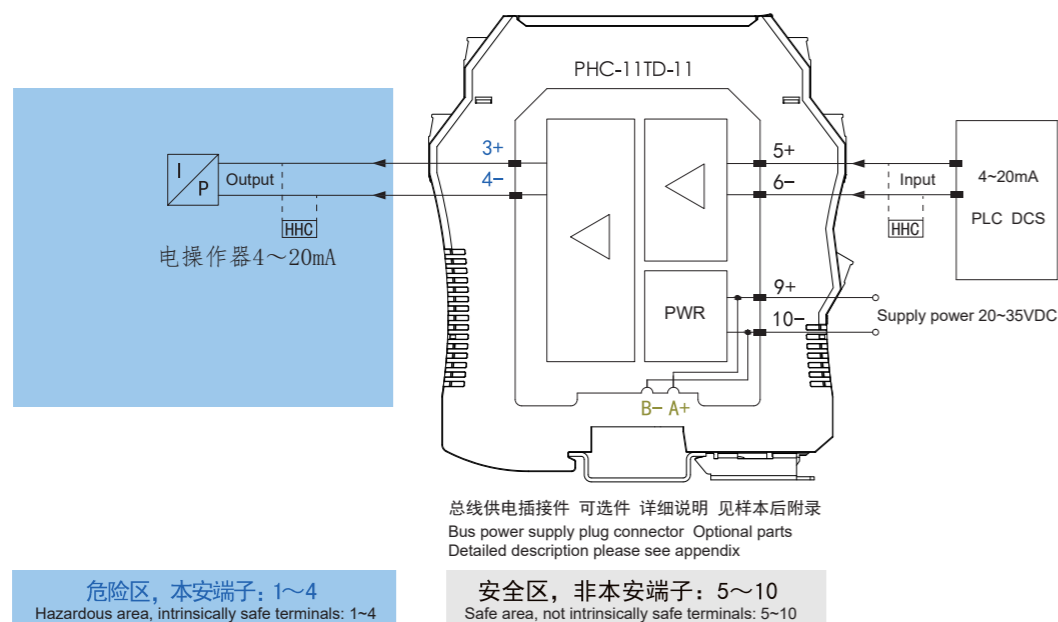

技术数据 Specifications

供电电压 Supply voltage	20~35VDC, 功耗约1.2W (24VDC, 输出20mA时) 20~35VDC, power consumption about 1.2W (when 24 VDC, output 20mA)
输入信号 Input signal	4~20mA (HART)
输出信号 Output signal	4~20mA (HART)
允许输出负载能力 Allowable output load capacity	0~500Ω (可定制) 0~500Ω (customizable)
输出精度 Output accuracy	0.1%F.S (典型值: 0.05%F.S) 0.1%F.S (Typical value: 0.05% F.S)
温度漂移 Temperature drift	0.005%F.S/°C
输入输出路数 Number of input and output	一路输入, 一路输出 1 input 1 output
适用的现场设备 Applicable field equipments	阀门定位器, 电/气转换器 Valve positioner, electric/pneumatic converter
温度参数 Temperature parameters	工作温度: -20°C~+60°C, 存储温度: -40°C~+80°C Working temperature: -20 C~+60 C, storage temperature: -40 C~+80 C
空气相对湿度 Relative humidity	10%~95%RH无凝露 10%~95% RH no condensation
绝缘强度 Insulation strength	本安端与非本安端 (≥3000VAC/min); 电源与非本安端之间 (≥1500VAC/min) Between intrinsically safe side and non-intrinsically safe side (≥3000VAC/min); between power supply and non-intrinsically safe side (≥1500VAC/min)
绝缘电阻 Insulation resistance	≥100MΩ (输入/输出/电源间) ≥100MΩ (between input/output/power supply)
电磁兼容性 Electromagnetic compatibility	符合IEC 61326-1 (GB/T 18268), IEC 61326-3-1 According to IEC 61326-1 (GB/T 18268), IEC 61326-3-1
防爆标志 Explosion-proof mark	[Exia Ga] IIC
功能安全认证 Functional safety certification	SIL2 符合IEC 61508 EN 61511标准 SIL2 according to IEC 61508 and EN 61511 standards
认证机构 Certification body	国家防爆电气产品质量监督检验中心CQST认证 CQST (China National Quality Supervision and Test Centre for Explosion Protected Electrical Products)
认证参数 (端子3-4之间) Certified parameters (between terminals 3-4)	Um=250V Uo=28V Io=93mA Co=0.05 μF Lo=2.4mH Po=0.65W
安装场所要求 Installation place requirements	可与具有IIA、IIB、IIC危险气体的0区本安仪表相连接 It can be connected with instruments in 0 zone with IIA, IIB, IIC dangerous gas
平均无故障时间 MTBF	约100000小时 About 100000h

端子定义及外形尺寸 Terminal assignments and dimensions

端子 Terminal	接线端子功能定义 Terminal assignments	
9	供电电源+ Power supply +	20~35VDC
10	供电电源- Power supply -	
5	输入+ Input+	4~20mA
6	输入- Input-	
3	输出+ Output+	4~20mA
4	输出- Output-	

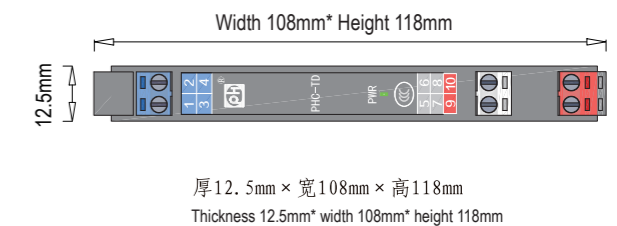

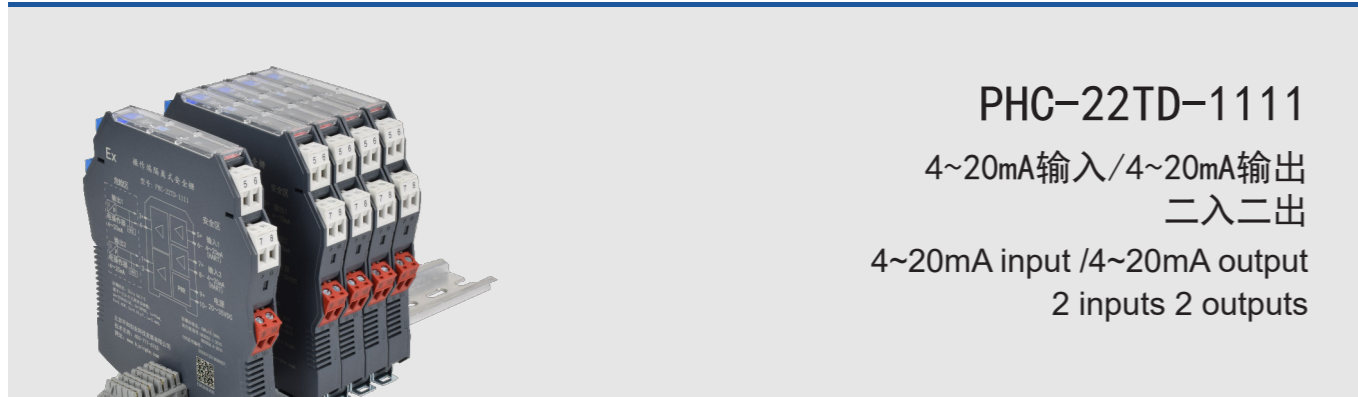

概述 Overview

隔离式操作端安全栅PHC-22TD-1111，模拟量输入输出，两路输入两路输出。

安全栅可将安全区4~20mA信号传输到危险区，驱动现场的阀门定位器、电/气转换器等执行机构工作。

本产品需要外接20~35VDC电源。

电源、输入、输出三端隔离。

*总线端子供电，详见附录。

Isolated safety barrier at operating side: PHC-22TD-1111, dual input and dual output with analog signal.

The safety barrier can transmit the 4~20mA signal from safe area to the dangerous area, to drive the valve positioner, electric/gas converters and other actuators to work.

This product needs an external 20~35VDC power supply.

Terminal isolation between power supply, input and output.

* Bus terminal power supply, please see appendix for details.

接线图 Wiring diagram

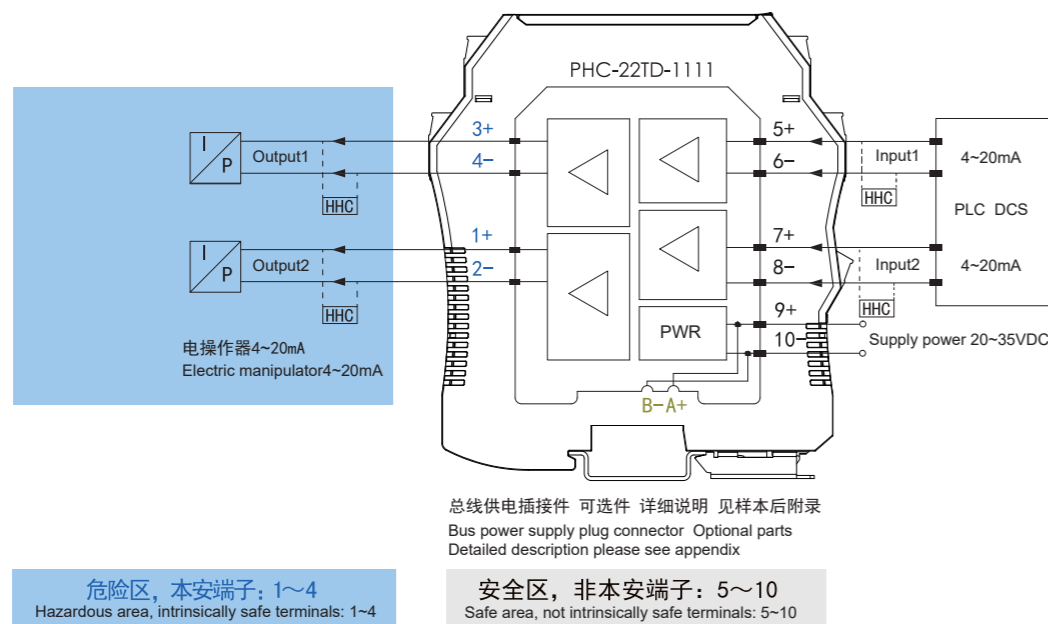

技术数据 Specifications

供电电压 Supply voltage	20~35VDC, 功耗约2W (24VDC, 输出20mA时) 20~35VDC, power consumption about 2W (when 24 VDC, output 20mA)
输入信号 Input signal	4~20mA (HART)
输出信号 Output signal	4~20mA (HART)
允许输出负载能力 Allowable output load capacity	0~500Ω (可定制) 0~500Ω (customizable)
输出精度 Output accuracy	0.1%F.S (典型值: 0.05%F.S) 0.1%F.S (Typical value: 0.05% F.S)
温度漂移 Temperature drift	0.005%F.S/°C
输入输出路数 Number of input and output	二路输入, 二路输出 2 inputs 2 outputs
适用的现场设备 Applicable field equipments	阀门定位器, 电/气转换器 Valve positioner, electric/pneumatic converter
温度参数 Temperature parameters	工作温度: -20°C~+60°C, 存储温度: -40°C~+80°C Working temperature: -20 C~+60 C, storage temperature: -40 C~+80 C
空气相对湿度 Relative humidity	10%~95%RH无凝露 10%~95% RH no condensation
绝缘强度 Insulation strength	本安端与非本安端 (≥3000VAC/min); 电源与非本安端之间 (≥1500VAC/min) Between intrinsically safe side and non-intrinsically safe side (≥3000VAC/min); between power supply and non-intrinsically safe side (≥1500VAC/min)
绝缘电阻 Insulation resistance	≥100MΩ (输入/输出/电源间) ≥100MΩ (between input/output/power supply)
电磁兼容性 Electromagnetic compatibility	符合IEC 61326-1 (GB/T 18268), IEC 61326-3-1 According to IEC 61326-1 (GB/T 18268), IEC 61326-3-1
防爆标志 Explosion-proof mark	[Exia Ga] IIC
认证机构 Certification body	国家防爆电气产品质量监督检验中心CQST认证 CQST (China National Quality Supervision and Test Centre for Explosion Protected Electrical Products)
认证参数 (端子1-2, 3-4之间) Certified parameters (between terminals 1,2, 3,4)	Um=250V Uo=28V Io=93mA Co=0.05 μF Lo=2.4mH Po=0.65W
安装场所要求 Installation place requirements	可与具有IIA、IIB、IIC危险气体的0区本安仪表相连接 It can be connected with instruments in 0 zone with IIA, IIB, IIC dangerous gas
平均无故障时间 MTBF	约100000小时 About 100000h

端子定义及外形尺寸 Terminal assignments and dimensions

端子 Terminal	接线端子功能定义 Terminal assignments
9	供电电源+ Power supply +
10	供电电源- Power supply -
5	输入1+ Input1+
6	输入1- Input1-
7	输入2+ Input2+
8	输入2- Input2-
3	输出1+ Output1+
4	输出1- Output1-
1	输出2+ Output2+
2	输出2- Output2-

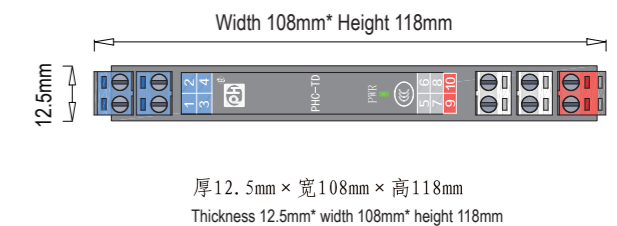

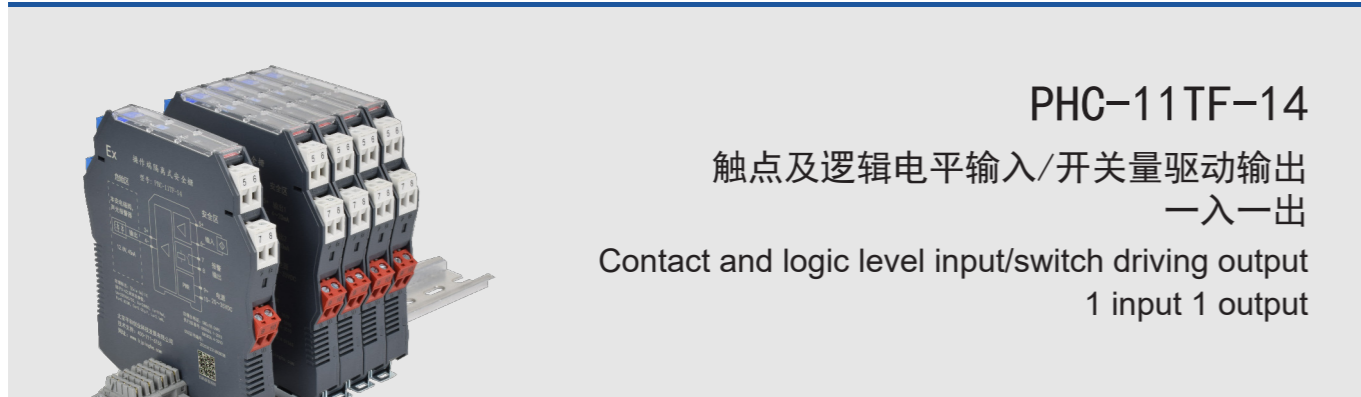

PHC-11TF-14
触点及逻辑电平输入/开关量驱动输出
一入一出
Contact and logic level input/switch driving output
1 input 1 output

概述 Overview

隔离式操作端安全栅：PHC-11TF-14，开关量输入输出，一路输入一路输出。

安全栅可实现将安全区的触点开关、逻辑电平输入量，转换为本安设备的驱动量，输出到危险区现场，从而控制电磁阀，声光报警器等。

信号状态指示灯设红黄双色，报警显示红色，输出电磁阀等工作显示为黄色。

本产品需要外接20~35VDC电源

*总线端子供电，详见附件。

Isolated safety barrier at operating side: PHC-11TF-14, switch input and output, single input and single output.

Safety barrier can convert the input quantity of contact switch and logic level in safety area into the driving quantity of intrinsically safe equipments, and output it to the field of dangerous area, so as to control solenoid valve, audible and visual alarm, etc. The status indicator has red and yellow light colors, when for alarming the light is red, when it is with the output solenoid valve, then the light is yellow. This product needs an external 20~35VDC power supply

* Bus terminal for power supply, please see the appendix for details.

接线图 Wiring diagram

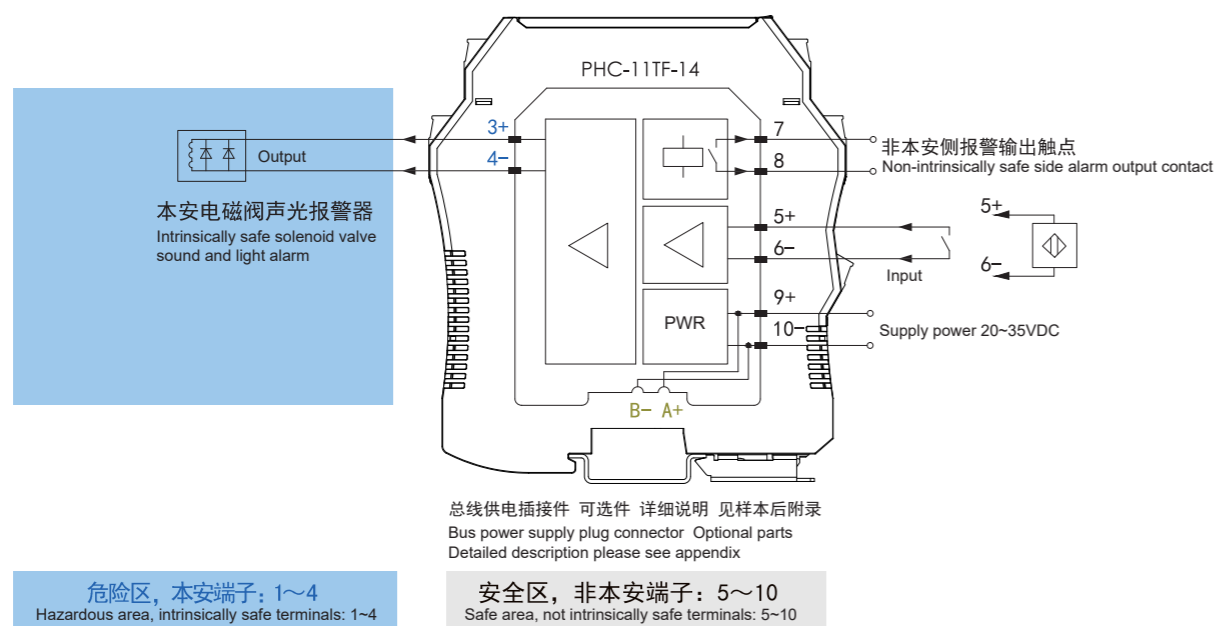

技术数据 Specifications

供电电压 Supply voltage	20~35VDC, 功耗约2.2W 20~35VDC, power consumption about 2.2W
输入信号 Input signal	开关触点, 逻辑电平 Switch contact, logic level
输出信号 Output signal	开路电压>24V, UE/IE=12.8V/45mA. 置反功能: K1置“ON”侧, 电路输出置反 Open circuit voltage >24V, UE/IE=12.8V/45mA. Inversion function: K1 is set to the "ON" side, the circuit output is inverted.
报警继电器功能 Alarm relay function	拨码开关K2置“ON”侧, 电路选用报警功能 负载电阻<50Ω, 短路报警(SC), 负载电阻>10KΩ, 开路报警(LB) The dial switch K2 is set to the "ON" side, the circuit adopts the alarm function Load Resistance<50Ω, short-circuit alarm (SC), load resistance >10KΩ, open circuit alarm (LB)
报警继电器输出特性 Alarm relay output characteristics	响应时间: 20ms, 驱动能力: 250VAC/2A, 30VDC/2A电阻性负载时 Response time: 20ms, driving capacity: 250VAC/2A, 30VDC/2A under resistive load
输入输出路数 Number of input and output	一路输入, 一路输出 1 input 1 output
适用的现场设备 Applicable field equipments	本安电磁阀、声光报警器 Safety solenoid valve, audible and visual alarm
温度参数 Temperature parameters	工作温度: -20℃~+60℃, 存储温度: -40℃~+80℃ Working temperature: -20 C ~+60 C, storage temperature: -40 C ~+80 C
空气相对湿度 Relative humidity	10%~95%RH无凝露 10%~95% RH no condensation
绝缘强度 Insulation strength	本安端与非本安端 (≥3000VAC/min); 电源与非本安端之间 (≥1500VAC/min) Between intrinsically safe side and non-intrinsically safe side (≥3000VAC/min); between power supply and non-intrinsically safe side (≥1500VAC/min)
绝缘电阻 Insulation resistance	≥100MΩ (输入/输出/电源间) ≥100MΩ (between input/output/power supply)
电磁兼容性 Electromagnetic compatibility	符合IEC 61326-1 (GB/T 18268), IEC 61326-3-1 According to IEC 61326-1 (GB/T 18268), IEC 61326-3-1
防爆标志 Explosion-proof mark	[Exia Ga] IIC
功能安全认证 Functional safety certification	SIL2 符合IEC 61508 EN 61511标准 SIL2 according to IEC 61508 and EN 61511 standards
认证机构 Certification body	国家防爆电气产品质量监督检验中心CQST认证 CQST(China National Quality Supervision and Test Centre for Explosion Protected Electrical Products)
认证参数 (端子3-4之间) Certified parameters (between terminals 3-4)	Um=250V Uo=28V Io=119mA Co=0.05 μF Lo=2.1mH Po=0.83W
安装场所要求 Installation place requirements	可与具有IIA、IIB、IIC危险气体的0区本安仪表相连接 It can be connected with instruments in 0 zone with IIA, IIB, IIC dangerous gas
平均无故障时间 MTBF	约100000小时 About 100000h

端子定义及外形尺寸 Terminal assignments and dimensions

端子 Terminal	接线端子功能定义 Terminal assignments
9	供电电源+ Power supply +
10	供电电源- Power supply -
5	输入+ Input+
6	输入- Input-
3	输出+ Output+
4	输出- Output-
7	报警输出 Alarm Output
8	报警输出 Alarm Output

